



CONNECT AND PROTECT

Mineral Insulated Wiring Cable System



PYROTENAX

nVent PYROTENAX MI The Ultimate Fire Survival MI Wiring Cable System for Versatility and Ultimate Fire Survival Performance



nVent PYROTENAX MI Cable Systems were installed when fire broke out in the Channel Tunnel in November 1996. Resisting extreme temperatures that destroyed concrete and welded rails, the Pyro MI Wiring Cable allowed emergency lighting to operate for the safe evacuation of passengers; proving its superior fire survival capability.

Pyro MI Fire Survival Cable System - provides the ideal solution to many difficult and demanding wiring installations making a permanent and dependable wiring cable system for all low and medium voltage applications. Safe in hazardous installations and radio active environments. Exceeds all world wide fire performance standards. The Pyro MI Cable System is the natural choice for domestic, commercial and industrial applications.



CONTENTS

Introduction and Contents	2-3
Pyro MI Enhanced Grade Wiring Cable System	4
Pyro Twist Cable System	5
Pyro MI Typical Applications	6
Pyro MI Standards & Approvals	7
Fire Performance	8
London Underground Limited Test for Fire Survivable Cable	9
Pyro MI Cable System Data and Accessory Selection	10
Pyro MI Cable System Terminations	12
Terminating Procedure	13
Pyro MI Cable Fixings	14
Pyro MI Coils, Reels and Drums	15

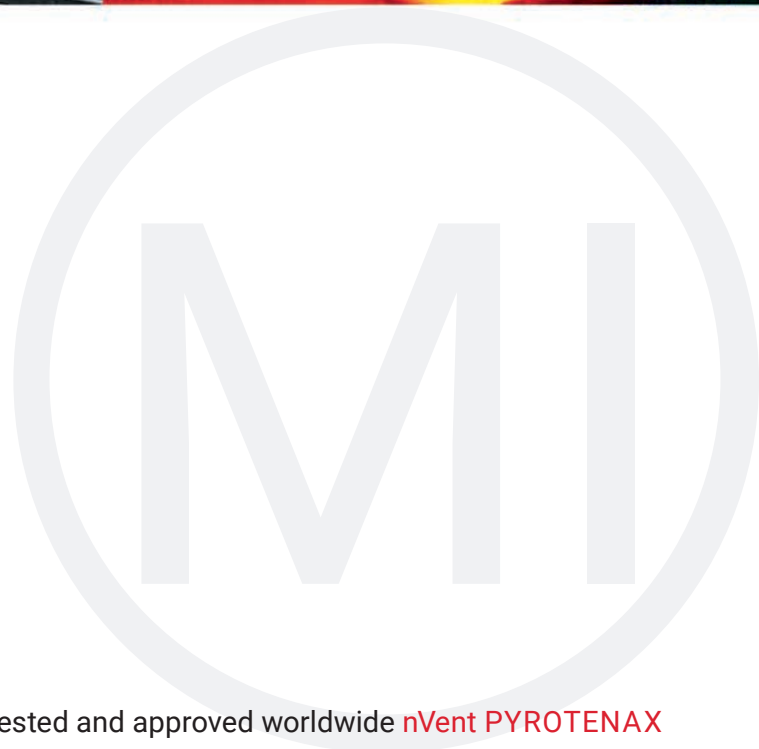

Pyro MI Tried, tested and approved worldwide nVent **PYROTENAX**

nVent.com/PYROTENAX | 3

Pyro MI Enhanced Grade Wiring Cable System

PYRO MI RANGE

The standard range of Pyro MI Cable provides the ideal solution for almost all electrical circuits in the low voltage category.

Two voltage grades - 500 and 750 Volts, are available with conductors from 1.0 sq.mm to 240 sq.mm. A full range of complementary accessories and tools provides a complete wiring system supplied and supported by the "Genuine nVent PYROTENAX" component assurance.

PYRO MI BENEFITS

- ▶ Pyro MI survives the fire test requirements for enhanced grade cables as defined in BS 5839: part 1
- ▶ Peace of mind from the third party (LPCB) approval for categories C, W and Z in BS 6387
- ▶ Also attains categories C, W and Z of BS 6387 with one single cable sample

PYRO MI CONSTRUCTION

With a basic inorganic construction of a copper sheath and conductors, together with a mineral insulant, the cable provides a unique combination of dependability, versatility and permanence.

This construction, with the melting points of 1083°C and 2800°C for the copper and the insulant respectively, provides the unsurpassed Fire Survival properties which enable the cable to continue to carry current at temperatures in excess of 1000°C.

PYRO MI CONSTRUCTION CHARACTERISTICS

- ▶ Fireproof
- ▶ High Operating Temperatures
- ▶ Inherent Flameproof Barrier
- ▶ Zero Energy
- ▶ Non-Ageing
- ▶ Great Mechanical Strength
- ▶ Small Overall Diameter
- ▶ Pliable
- ▶ Wiring Cable and Conduit Combined
- ▶ Competitive Installed Cost
- ▶ High Degree of Electrical Screening
- ▶ Radiation Resistant
- ▶ Integral Earth Continuity
- ▶ High Corrosion Resistance
- ▶ Waterproof

Copper
Conductor

Compressed
Mineral Insulant

Copper
Sheath

Halogen Free LSF
Outer Covering

Standard colours are Orange, Red, White and Black. Other colours such as Stone, Blue, Grey etc. are also available subject to minimum order requirements.



Pyro Twist Cable System

PYRO MI RANGE

Pyro Twist is a range of communication and signal cables for life preservation and integrated building management systems.

They have been developed from the proven characteristics of Pyro MI to maintain the security of vital signals in communication and data networks, particularly in hostile conditions.

PYRO TWIST ADDITIONAL CHARACTERISTICS AND ADVANTAGES

- ▶ Twisted conductor configuration with a solid copper screen
- ▶ Pyro Twist available in red (other colours available upon request)
- ▶ Pyro Twist uses standard accessories for the equivalent Pyro MI Light Duty cable size
- ▶ Pyro Twist can be installed and terminated by following the normal procedures for Pyro MI Cable
- ▶ The twisted copper conductor configuration enhances the EMC noise rejection characteristics, reducing the possibility of system malfunction
- ▶ The exceptionally low impedance of the solid copper sheath provides a superior EMC screening than other cable systems
- ▶ Minimal smoke obscuration in the event of fire

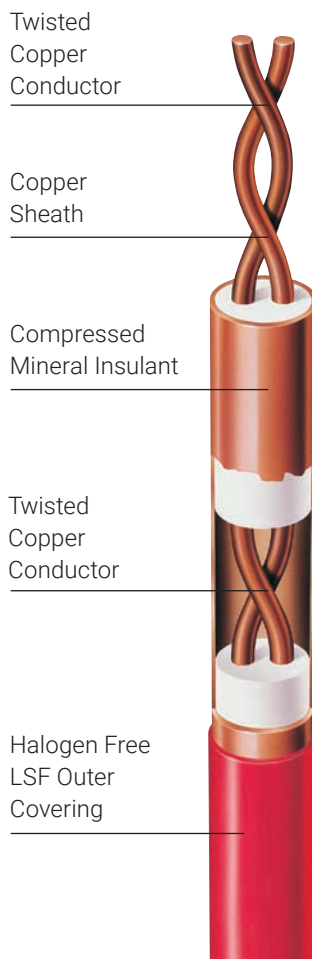

Pyro MI survived in this high rise office complex fire

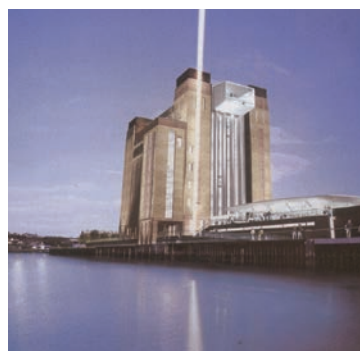

Pyro MI Typical Applications

- Moving Walkways
- Car Parking
- Public Buildings
- Metro Links
- Hotels
- Shopping Complexes
- Building Services
- Offshore
- Rail Tunnels
- Road Tunnels
- Dock and Harbour
- Original Equipment
- Building Exteriors
- Power Generating
- Escalators
- Transport/Interchanges
- Petrol Stations
- Petrochemicals
- Airport
- Water Treatment

PYRO MI WORLDWIDE MAJOR PROJECTS

The following is a very brief list of products where Pyro MI Cables have been extensively specified and installed in situations demanding circuit integrity in the most critical situations.

Thermal Power Stations - Gas, Coal, Oil and Nuclear

Project	Location
Fawley	United Kingdom
Fiddler's Ferry	United Kingdom
Doha West	Kuwait
Nkand Mine	Zambia
Ap Lei Chan	Hong Kong
Heysham	United Kingdom
Kalpakam	India
Torness	United Kingdom
Hartlepool	United Kingdom
Marvikien	Sweden
Latina	Italy
Solovakia Al	Slovakia
Torre	Italy
Kalkar (FBR)	Germany
Dungeness (A&B)	United Kingdom
Rihand	India
Trillo (PWR)	Spain
Monju (FBR)	Japan
Sabiya	Kuwait
Taweelaah'B'	Abu Dhabi
Blackpoint	Hong Kong

Major Oil Companies Specifying nVent PYROTENAX for On and Offshore Installations.

Reference List

- Kuwait Oil Company (KOC)
- Kuwait National Petroleum Co (KNPC)
- ARAMCO
- Petromin - Saudi Arabia
- National Iranian Oil Company
- Royal Dutch Shell - Netherlands
- Union Oil
- EXXON
- Abu Dhabi National Oil Company (ADNOC)
- Shell UK
- Chevron, Statoils
- Qatar General Petroleum Corporation
- BP Chemicals
- Oil & Natural Gas Company - India (ONGC).

Production Platforms - Oil and Gas

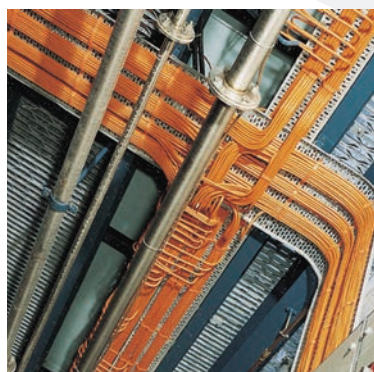

Pyro MI survived in this power station fire

Pyro MI Standards & Approvals

Throughout the world Pyro MI Fire Survival Wiring products are used for vital communication and power distribution.

Pyro MI Middle East Major Projects

Pyro MI Cables have been selected and approved for use in Middle East Projects by an impressive number of renowned specifiers as shown below.

The list of projects where Pyro MI Cables have been installed is much longer than, those mentioned below.

Project References

Dubai International Airport
 Bahrain International Airport
 Riyadh International Airport
 Muscat International Airport
 Kuwait International Airport
 North Dome - QGPC Qatar
 Gulf Hotel - Bahrain
 Sheraton - Doha
 Alba - Bahrain Aluminium Smelter
 Dubai - Dubai Aluminium Smelter
 Sharjah Suk
 Dubai 'G' Power Station
 Dubai 'F' Power Station
 Sabiya Power Station Kuwait
 ADNOC Das Island - Gas Storage
 Doha East Power Station - Kuwait
 Doha West Power Station - Kuwait
 Etisalat Telecommunications
 Building - Abu Dhabi
 Mew Sub-Stations
 Holiday Inn Crown Plaza - Dubai
 Riyadh University Hospital
 Al Zoor Power - Kuwait
 Ras Abu Fontas P S Qatar
 ADNOC HQ Building Abu Dhabi
 Bahrain Islamic Bank
 BATELCO - Bahrain
 National Bank of Dubai
 Al Wasl Hospital - Dubai
 Chamber of Commerce
 Buildings - Dubai
 Hilton Apartments - Kuwait
 SECO Sub-Station - Saudi Arabia
 Diplomatic Area - Riyadh
 Jubail Port - Saudi Arabia
 Damman Port - Saudi Arabia
 Jeddah Port - Saudi Arabia
 Jebel Ali Port - Dubai

Road Tunnels

Project	Location
Kai Tak	Kowloon - Hong Kong
Mersey Kingsway	Liverpool - United Kingdom
Mersey Queensway	Liverpool - United Kingdom
Tyne	Newcastle - United Kingdom
Lewes	Lewes - United Kingdom

Rail Tunnels

Brussels Metro, London Underground, Mass Transit Rail Loop, Montreal Metro, Newcastle Metro, Paris Metro, Glasgow Underground, Merseyside Underground Loop, Channel Tunnel, Vienna Metro

Cables

nVent PYROTENAX MI Wiring Cables are manufactured, tested in accordance with, and LPCB approved to, BS EN 60702-1.

nVent PYROTENAX MI Wiring Cables are LPCB approved to BS 8434-2, BS 5839-1 Clause 26.2 (Enhanced), BS EN 50267-1, and BS EN 50200 Class PH 120. nVent PYROTENAX MI Wiring Cables have also been witnessed tested, by Lloyds Register, to the test requirements of BS7346-6.

Quality Certification



Assessed to ISO 9001
LPCB ref: 1659a



LPCB ref: 1659a/01

Terminations

nVent PYROTENAX Terminations are tested in accordance with BS EN 60702: Part 2. nVent PYROTENAX Terminations are Certified for use in potentially explosive atmospheres.

For ATEX approved glands, please contact nVent Thermal Sales for support.

nVent PYROTENAX cable drums, reels and termination packaging are marked with the CE mark as required by the low voltage directive, except for Terminations primarily intended for installation in potentially explosive atmospheres which are not marked, because the directive does not apply.

Other Standards and Codes of Practice Referring to MI Cables:

BS 8434- Methods of test for assessment of the fire integrity of electric cables Part1: Test for unprotected small cables for use in emergency circuits - BS EN 50200 with the addition of water spray.

Part 2: Test for unprotected small cables for use in emergency circuits - BS EN 50200 with a 930°C flame and with water spray.

BS 6387- 1994 Performance Requirements for Cables Required to Maintain Circuit Integrity under Fire Conditions.

IEC 60331- Tests for Electric Cables under fire conditions.

Underwriters Laboratories- UL2196-USA, ULC-S139-Canada. Tests for fire resistant cables.

London Underground- Fire Survival Cable (MICC) EME-SP-14-028-A1.

BS EN 60702-1 & 60702-2- Mineral Insulated Cables and their Terminations.

BS 7671- Requirements for Electrical Installations (IEE Wiring Regulations).

BS 5588- Fire Precautions in the design, construction and use of buildings,

BS 5266- Emergency Lighting.

BS 60079- Code of Practice for the selection, installation and maintenance of electrical apparatus for use in Potentially Explosive Atmospheres.

BS 5454- Storage and exhibition of Archival Documents.

BS 5839- Fire detection and alarm systems in Buildings.

The Institute of Petroleum Guidance for the design, Construction, Modification and Maintenance of Petrol Filling Stations. Electrical Installations.

C.I.O. Lighting and Wiring of Churches.

Fire Performance

Pyro MI easily meets and exceeds the BS 5839-1 Enhanced and Standard Grade Requirements

The BS 5839-1 (Fire detection and alarm systems for buildings – Part 1: Code of practice for system design, installation, commissioning and maintenance) describes two levels of fire performance for fire rated cabling for fire alarm systems. These performance levels have now been published within a British Standard. BS 8434 Parts 1 and 2 (Methods of test for the assessment of the fire integrity of electric cables.

Pyro MI easily complies with and exceeds all the requirements for **Enhanced Grade** and **Standard Grade** described within these new standards and is LPCB approved.

Pyro MI is the obvious choice for both **Standard Grade** and **Enhanced Grade** critical signal paths.

Fire Performance BS 6387 Performance Requirements for Cables Required to Maintain Circuit Integrity under Fire Conditions.

This standard details the following tests to categorise cables according to their fire withstand capabilities.

Resistance to Fire 950°C for 3 hours – Category C

The cable is tested by exposure to gas burner flames while passing a current at its rated voltage. Four survival categories are defined in the Performance Table below.

Performance Table

	Symbol	Pyro MI
650°C for 3 hours	A	Surpasses
750°C for 3 hours	B	Surpasses
950°C for 3 hours	C	Surpasses
950°C for 20 minutes	S	Surpasses

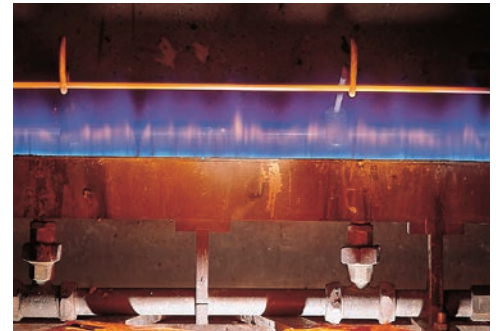

Resistance to Fire with Water Spray 650°C – Category W

A new sample of cable is exposed to flames at 650°C for 15 minutes whilst passing a current at the rated voltage and then the spray is turned on to give exposure to both fire and water for a further 15 minutes.

A single survival category is defined in the Performance Table below.

Performance Table

	Symbol	Pyro MI
650°C for 3 hours	W	Surpasses



Resistance to Fire with Mechanical Shock 950°C Category Z

The final requirement is mechanical shock damage. A fresh sample of cable is mounted on a backing panel in an S-bend and is exposed to flames whilst the backing panel is struck with a solid steel bar the same diameter as the cable under test every 30 seconds for 15 minutes. Whilst the cable has been exposed to temperatures as defined in the Performance Table below.

Performance Table

	Symbol	Pyro MI
650°C	X	Surpasses
750°C	Y	Surpasses
950°C	Z	Surpasses

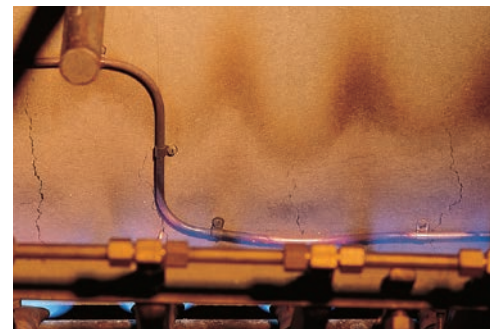

**“Beyond the Standard...
Pyro MI Cable can easily comply and withstand the most onerous categories of C, W and Z using one single Cable Sample**

London Underground Limited Test for Fire Survivable Cable

To fully assess the Fire Survival qualities of Pyro MI Cable and in response to requests from major specifiers, more rigorous testing criteria have been devised. The aim of the tests is to extend the conditions of BS 6387 to effectively recreate a more realistic fire situation by exposing the cable to significant thermal and physical shock.

In a fire environment cable has to survive not only the extremes of high temperature but also the impact from falling debris together with water exposure from fire fighting equipment.

In the aftermath of a fire the cable must also withstand bending, further impact and possible water immersion during building and structural restoration.



Cable struck directly with a steel bar (at the centre of the burner) every 10 minutes during a 3 hour period in a flame at 950°C.



Cable then sprayed with water for 15 minutes whilst still being struck by the bar.



Cable then bent at the point of impact through 180°.

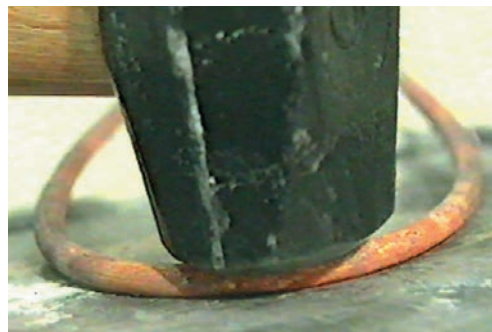

Further mechanical impact shock.



Close-up of cable subjected to the LUL Test.

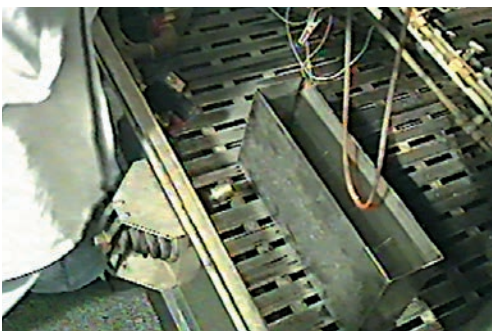











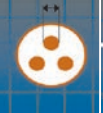

Finally immersed in water for 1 hour whilst energised at its rated voltage.

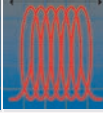

Pyro MI survived in this department store fire

Pyro MI Cable System Data and Accessory Selection

Pyro MI Enhanced Grade Fire Survival Cable

CABLE SIZE REFERENCE BARE CABLE/CCSF COVERED CCM	NUMBER & CROSS SECTIONAL AREA OF CONDUCTORS	CABLES EXPOSED TO TOUCH			CABLE DIAMETER		APPROXIMATE NOMINAL CONDUCTOR DIAMETER	APPROXIMATE LONGEST BARE COIL LENGTHS FOR ESTIMATING PURPOSES	COIL DIAMETERS	APPROX. WEIGHT PER 1000 M		SCREW ON SEAL 105°C					
		CURRENT RATINGS		VOLT DROP	LSF	BARE				LSF	BARE	LSF	BARE	PLAIN SEAL	EARTH TAIL SEAL		
		LSF	BARE													PER AMP PER METRE	
																	
Followed By	No. x sq mm	amps**	amps**	mV**	mm	mm	m	mm	kg		RPS	RPSL					
Light Duty 500V Grade																	
2L1	2x1	19.5	17.5	42	6.6	5.1	1.13	+1800◆	500	125	104	2L1	20	2L1	20		
2L1.5	2x1.5	25	22.5	28	7.2	5.7	1.39	+1400◆	++500	159	136	2L1.5	20	2L1.5	20		
2L2.5	2x2.5	33	30	17	8.1	6.6	1.77	+1100◆	++500	213	187	2L2.5	20	2L2.5	20		
2L4	2x4	44	40	10	9.4	7.7	2.25	800	915	282	248	2L4	20	2L4	20		
3L1*	3x1	16.5	15	36	7.3	5.8	1.13	+1500	500	159	136	3L1	20	3L1	20		
3L1.5*	3x1.5	21	19	24	7.9	6.4	1.39	+1100◆	500	201	176	3L1.5	20	3L1.5	20		
3L2.5*	3x2.5	28	25	14	9.0	7.3	1.77	900	915	256	223	3L2.5	20	3L2.5	20		
4L1*	4x1	16	14.5	36	7.8	6.3	1.13	+1200	500	187	162	4L1	20	4L1	20		
4L1.5*	4x1.5	21	19	24	8.5	7.0	1.39	+900	500	230	203	4L1.5	20	4L1.5	20		
4L2.5*	4x2.5	28	25	14	9.8	8.1	1.77	700	915	313	277	4L2.5	20	4L2.5	20		
7L1	7x1	11	10	42	9.3	7.6	1.13	800	915	269	236	7L1	25	7L1	25		
7L1.5	7x1.5	14	12.5	28	10.1	8.4	1.39	600	915	332	295	7L1.5	25	7L1.5	25		
7L2.5	7x2.5	19	17	17	11.4	9.7	1.77	500	915	454	411	7L2.5	25	7L2.5	25		
Heavy Duty 750 V Grade																	
1H10*	1x10	90	81	3.6	9.0	7.3	3.57		950	915	273	240	1H10	20	1H10	25	
1H16*	1x16	119	107	2.3	10.0	8.3	4.50		740	915	361	326	1H16	20	1H16	25	
1H25*	1x25	154	139	1.5	11.3	9.6	5.66		540	915	499	457	1H25	20	1H25	32	
1H35*	1x35	187	168	1.1	12.4	10.7	6.66		435	1370	632	585	1H35	20	1H35	32	
1H50*	1x50	230	207	0.87	13.8	12.1	7.75		345	1370	810	758	1H50	25	1H50	40	
1H70*	1x70	279	251	0.65	15.4	13.7	9.32		270	1370	1075	1016	1H70	25	-		
1H95*	1x95	333	300	0.53	17.7	15.4	10.98		215	1370	1413	1324	1H95	25	-		
1H120*	1x120	382	344	0.46	19.1	16.8	12.33		185	1370	1709	1612	1H120	32	-		
1H150*	1x150	431	388	0.42	20.7	18.4	13.70		155	1370	2055	1949	1H150	32	-		
1H185*	1x185	482	434	0.39	23.2	20.4	15.18		125	1370	2514	2370	1H185	32	-		
1H240*	1x240	537	483	0.36	26.1	23.3	17.33		98	1370	3213	3050	1H240	40	-		
2H1.5	2x1.5	26	23.5	28	9.6	7.9	1.39		750	915	272	237	2H1.5	20	2H1.5	20	
2H2.5	2x2.5	36	32	17	10.4	8.7	1.77		610	915	314	276	2H2.5	20	2H2.5	20	
2H4	2x4	47	42	10	11.5	9.8	2.25		480	915	397	355	2H4	20	2H4	25	
2H6	2x6	60	54	7	12.6	10.9	2.75		370	1370	493	446	2H6	20	2H6	25	
2H10	2x10	82	74	4.2	14.4	12.7	3.57		280	1370	673	619	2H10	25	2H10	32	
2H16	2x16	109	98	2.6	16.4	14.7	4.50		205	1370	912	850	2H16	25	2H16	40	
2H25	2x25	142	128	1.65	19.4	17.1	5.66		150	1370	1277	1178	2H25	32	2H25	40	
3H1.5*	3x1.5	22	20	24	10.0	8.3	1.39		670	915	290	254	3H1.5	20	3H1.5	20	
3H2.5*	3x2.5	30	27	14	11.0	9.3	1.77		520	915	364	323	3H2.5	20	3H2.5	25	
3H4*	3x4	40	36	9.1	12.1	10.4	2.25		420	1370	460	415	3H4	20	3H4	25	
3H6*	3x6	51	46	6	13.2	11.5	2.75		345	1370	575	526	3H6	25	3H6	25	
3H10*	3x10	69	62	3.6	15.3	13.6	3.57		245	1370	812	754	3H10	25	3H10	32	
3H16*	3x16	92	83	2.3	17.9	15.6	4.50		180	1370	1124	1034	3H16	25	3H16	40	
3H25*	3x25	120	108	1.45	20.5	18.2	5.66		135	1370	1549	1444	3H25	40	3H25	40	
4H1.5*	4x1.5	23	20.5	24	10.8	9.1	1.39		560	915	345	305	4H1.5	20	4H1.5	20	
4H2.5*	4x2.5	30	27	14	11.8	10.1	1.77		445	1370	428	384	4H2.5	20	4H2.5	25	
4H4*	4x4	40	36	9.1	13.1	11.4	2.25		350	1370	556	507	4H4	25	4H4	25	
4H6*	4x6	51	46	6	14.4	12.7	2.75		270	1370	698	644	4H6	25	4H6	32	
4H10*	4x10	68	61	3.6	16.5	14.8	3.57		205	1370	974	911	4H10	25	4H10	32	
4H16*	4x16	89	80	2.3	19.6	17.3	4.50		145	1370	1386	1286	4H16	32	4H16	40	
4H25*	4x25	116	104	1.45	22.9	20.1	5.66		110	1370	1947	1805	4H25	40	4H25	40	
7H1.5	7x1.5	15.5	14	28	12.5	10.8	1.39		385	1370	479	432	7H1.5	25	7H1.5	25	
7H2.5	7x2.5	21	19	17	13.8	12.1	1.77		310	1370	611	559	7H2.5	25	7H2.5	25	
12H1.5	12x1.5	13	11.5	28	15.8	14.1	1.39		210	1370	772	712	12H1.5	32	-		
12H2.5	12x2.5	17	15.5	17	17.9	15.6	1.77		175	1370	1001	911	12H2.5	32	-		
19H1.5	19x1.5	11	10	28	18.9	16.6	1.39		150	1370	1088	992	19H1.5	40	-		

Values quoted are nominal lengths only. Please contact our customer service department for confirmation of exact available lengths.



EXTERNALLY THREADED GLAND				PYRO BARE AND LSF COVERED CLIPS AND SADDLES					
FOR PLAIN SEAL		FOR EARTH TAIL SEAL		PYRO CLIP		PYRO SADDLE		CABLE SIZE REFERENCE BARE CABLE CC LSF COVERED CCM	
RGM	RGM	RC	RCHL	RS	RSFL	FOLLOWED BY			
Light Duty 500 V Grade									
2L1	20	2L1	20	20	26	202	272	2L1	
2L1.5	20	2L1.5	20	22	28	222	302	2L1.5	
2L2.5	20	2L2.5	20	26	32	272	342	2L2.5	
2L4	20	2L4	20	30	37	302	382	2L4	
3L1	20	3L1	20	22	28	242	302	3L1*	
3L1.5	20	3L1.5	20	24	30	272	342	3L1.5*	
3L2.5	20	3L2.5	20	28	34	302	342	3L2.5*	
4L1	20	4L1	20	24	30	272	342	4L1*	
4L1.5	20	4L1.5	20	28	34	302	342	4L1.5*	
4L2.5	20	4L2.5	20	32	37	342	422	4L2.5*	
7L1	25	7L1	25	30	37	302	382	7L1	
7L1.5	25	7L1.5	25	32	40	342	422	7L1.5	
7L2.5	25	7L2.5	25	37	43	382	462	7L2.5	
Heavy Duty 750 V Grade									
1H10	20	1H10	25	28	34	302	342	1H10*	
1H16	20	1H16	25	32	37	342	422	1H16*	
1H25	20	1H25	32	37	43	382	462	1H25*	
1H35	20	1H35	32	40	47	422	502	1H35*	
1H50	25	1H50	40	47	54	502	542	1H50*	
1H70	25	-	-	54	59	542	632	1H70*	
1H95	25	-	-	59	67	632	702	1H95*	
1H120	32	-	-	63	75	702	752	1H120*	
1H150	32	-	-	71	79	752	812	1H150*	
1H185	32	-	-	79	88	812	932	1H185*	
1H240	40	-	-	88	101	932	1042	1H240*	
2H1.5	20	2H1.5	20	30	37	342	382	2H2.5	
2H2.5	20	2H2.5	20	34	40	342	422	2H4	
2H4	20	2H4	25	37	43	422	462	2H6	
2H6	20	2H6	25	43	47	462	502	2H10	
2H10	25	2H10	32	47	54	502	592	2H16	
2H16	25	2H16	40	54	63	592	702	2H25	
2H25	32	2H25	40	67	75	702	752	3H1.5*	
3H1.5	20	3H1.5	20	32	37	342	422	3H2.5*	
3H2.5	20	3H2.5	25	37	43	382	462	3H4*	
3H4	20	3H4	25	40	47	422	502	3H6*	
3H6	25	3H6	25	43	51	462	542	3H10*	
3H10	25	3H10	32	54	59	542	632	3H16*	
3H16	25	3H16	40	59	71	632	752	3H25*	
3H25	40	3H25	40	71	79	752	812	4H1.5*	
4H1.5	20	4H1.5	20	37	43	382	462	4H2.5*	
4H2.5	20	4H2.5	25	40	47	422	462	4H4*	
4H4	25	4H4	25	43	51	462	542	4H6*	
4H6	25	4H6	32	47	54	502	592	4H10*	
4H10	25	4H10	32	54	63	592	702	4H16*	
4H16	32	4H16	40	67	75	702	752	4H25*	
4H25	40	4H25	40	79	88	812	932	7H1.5	
7H1.5	25	7H1.5	25	43	47	462	502	7H2.5	
7H2.5	25	7H2.5	25	47	54	502	542	12H1.5	
12H1.5	32	-	-	54	59	592	632	12H2.5	
12H2.5	32	-	-	59	71	632	752	19H1.5	
19H1.5	40	-	-	63	71	702	752		

PYRO TWIST ACCESSORY DATA

CABLE REF CCM	PLAIN BRASS SCREW-ON SEAL REF RPS	EARTH TAIL BRASS SEAL REF RPSL	GLAND REF RGM
2T1	2L1 20	2L1 20	2L1 20
2T1.5	2L1.5 20	2L1.5 20	2L1.5 20
2T2.5	2L4 20	2L2.5 20	2L2.5 20
2T4	3L1.5 20	2L2.5 20	2L4 20
3T1.5	4L1.5 20	3L1.5 20	3L1.5 20
4T1.5	4L2.5 20	4L1.5 20	4L1.5 20
4T1.5	4L2.5 20	4L2.5 20	4L2.5 20

CABLE REF CCM	LSF GLAND SHROUD REF RHGMM	LSF PYRO CLIP REF RCHL	LSF PYRO SADDLE REF RSFL
2T1	20 RD	26 RD	271 RD
2T1.5	20 RD	28 RD	302 RD
2T2.5	20 RD	32 RD	342 RD
2T4	20 RD	37 RD	382 RD
3T1.5	20 RD	30 RD	342 RD
4T1.5	20 RD	34 RD	342 RD
4T2.5	20 RD	37 RD	422 RD

Coloured Conductor Slewing

Coloured sleeving is available in red, black, yellow/green and blue for conductor sizes from 1.00mm² to 2.5mm²

Ordering Reference Example: For 2.5 mm² Red sleeving, please use reference RZP 2.5 RD

Pyro Tag Earth Tail Washers

For certain sizes of conductor, a Pyro Tag Earth Tail Washer can be used instead of the Earth Tail Seal (Ref: RPSL). Pyro Tags are available with 1.5mm² and 2.5mm² conductor tails.

Ordering Reference Example: RLT 2.5 20

- * Current ratings and volt drop values are for 3 phase operation, single conductor cables installed horizontally spaced. All other values are for single phase operation.
 - ** Current ratings and volt drop values are based upon tables 4J1A & 4J1B of the latest BS 7671 16th edition of the IEE Wiring Regulations method 11 (cable on a perforated cable tray).
 - † These sizes are normally supplied in 100 m lengths, longer lengths are readily available on application.
 - †† These sizes are supplied as Pyro Reels.
 - m For all **serviced/covered cable** longest lengths please refer to nVent
- Standard supply length: 100 m
Longer lengths available by order

Note: Cables Ref 1H120 and larger, whose lengths are in excess of half of a full nominal coil, are supplied as standard on non-returnable plywood drums.

Pyro MI Cable System Terminations

SEALS AND INSULATORS

A seal is normally required at each end of a nVent PYROTENAX MI Cable to provide a means of electrical connection. The Standard Brass 105°C Seal is suitable for the majority of general wiring applications. However since nVent PYROTENAX Cables are used in a wide variety of environments, a comprehensive range of seals and insulators are available to suit every need. A complete termination comprises a seal to provide a means of electrical connection and a gland to secure the cable into the appropriate apparatus. Externally threaded brass compression glands are available with ISO metric threads as standard. Other thread forms are available on request. Internally threaded 20 mm ISO metric brass compression glands are available for the full range of 2, 3 and 4 conductor, 500 volt light duty cables.

Standard Seal

Continuous operating temperature range -80°C to 105°C . These standard seals are suitable for all general wiring applications. Available in plain or earth tail.

Typical seal references:
e.g. Plain-RPS 2L2.5 20
Earth Tail-RPSL2L2.5 20
e.g. Plain-RPS 2H6 20
Earth Tail-RPSL2H6 20



Use RMX Compound (not shown)

Increased Safety Seal

Continuous operating temperature range -20°C to 85°C . Intended for use with type of protection "e" in potentially explosive atmospheres. Available in plain and earth tail.

Typical seal references:
Plain-RPA2H6 20.
Earth Tail-RPAL2H6 25.

Use RMX Compound (not shown)



Fire Resistant Seal

When fire resistance is required, standard nVent PYROTENAX 105°C seal Ref. RPS may be used provided that the standard PVC sleeving is replaced by silicon elastomer coated glass braided sleeving Ref. RZPS.

Such seals will pass a circuit integrity test, essentially as given in BS 6387 for Category C, with seals in a 950°C flame for 3 hours. For 32 and 40 mm sizes

call Technical Support on:
Tel: 0191 419 8200.

Use this seal when radiation resistance is required, as it has been satisfactorily tested to 100 M Rad.

Use RMX Compound (not shown)



Terminating Procedure

Typical Pyro MI Brass Seal Assemblies

Seal with Stub Cap Pot Closure

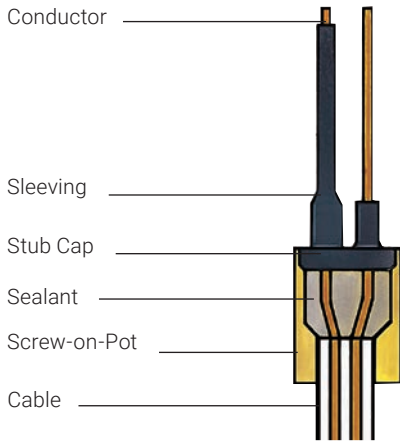

Seal with Disc Pot Closure

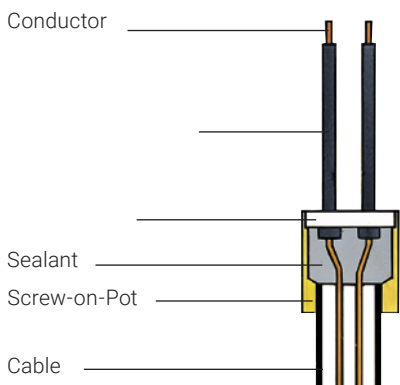

Earth Tail Seal with Stub Cap Pot Closure

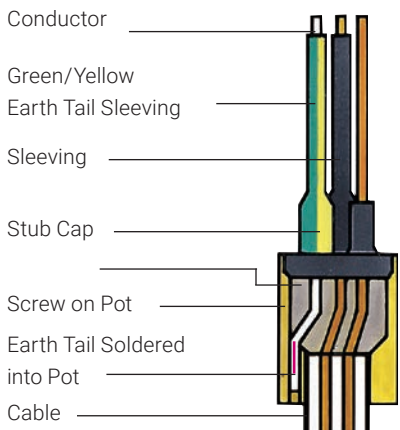

Typical Pyro MI Terminating Procedures

Preparing the Cable End

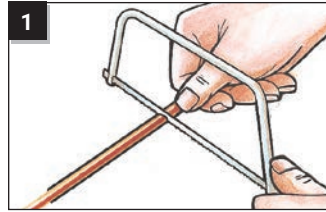

Cut cable end square.
Slide gland onto cable.

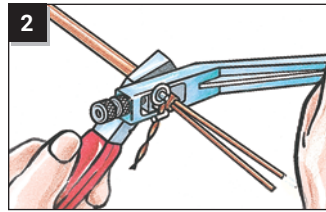

Apply Pyro Stripping Tool and turn clockwise to remove sheath. Use pliers to stop at required position.

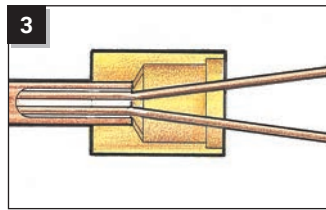

Using pliers or Pyro Potting Tool, screw seal pot onto cable to position shown. Remove any loose powder.



Completely fill the pot with compound from one side only.

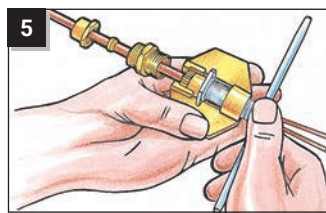

Using Pyro Crimping Tool compress compound and secure pot closure.

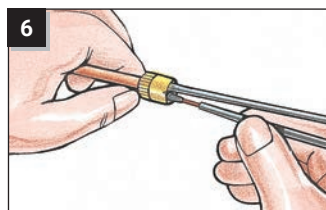

Fit conductor sleeving.

For detailed fitting instructions consult Installation Recommendation IR 200.

Pyro MI Cable Fixings

To secure pyro mi cable, far fewer fixings are required in comparison with other cable types. By using nVent PYROTENAX recommended fixing distances, savings of up to 40% can be achieved on fixing costs compared to conventional fixing distances.

Where considerable lengths of cable are involved, the savings can be very substantial - especially when matched against the cost of the cable itself.

Whether fixed on the surface, on a cable tray, behind plaster, in a roof space or suspended ceiling, Pyro MI Cable measures up to a real installation cost advantage.

The fixing distances shown in the table below represent a saving of up to 40% in comparison with traditional methods of installation practice, where pliable cables are fixed at an average of 225mm (9") intervals compared to the nVent PYROTENAX recommendation of 350mm (14") centre.



nVent PYROTENAX Recommended Fixing Distances

Fixing Distances Vertical

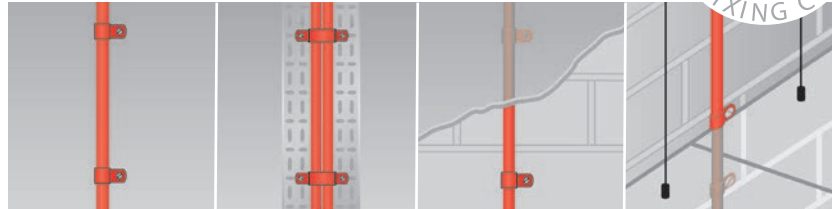

Cable Diameter	Surface	On Cable Tray	Behind Plaster	In Roof Space or Suspended Ceiling
Less than 9mm	550mm	800mm	600mm	550mm
9mm upto 20mm	600mm	1000mm	-	800mm
Over 20mm	650mm	1200mm	-	1000mm

Fixing Distances Horizontal

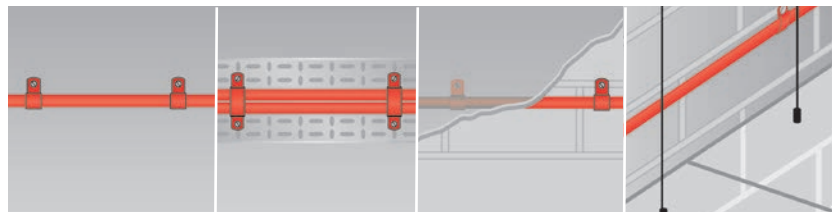

Cable Diameter	Surface	On Cable Tray	Behind Plaster	In Roof Space or Suspended Ceiling
Less than 9mm	450mm	800mm	600mm	550mm
9mm upto 20mm	500mm	1000mm	-	800mm
Over 20mm	550mm	1200mm	-	1000mm

PYRO MI SURVIVED



Pyro MI installed on launch pad gantry motors withstood take-off blast from space shuttle

Pyro MI Coils, Reels and Drums

Smaller Overall Diameter Gives More Compact Fixing Profile

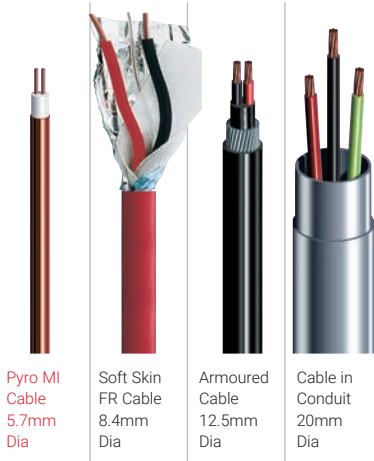

Cables shown approximately half size.

LSF Pyro Clips and Saddles from nVent PYROTENAX

The latest addition to the nVent PYROTENAX range is the new range of LSF and Halogen Free Cable Clips and Saddles. In addition to mechanical strength and fire safety advantages, they are colour matched against Pyro MI Cables and fixing sizes are easily visible when using them on site.



Pyro Strap

Two types of Pyro Strap are available, pre-punched or solid copper. Both types are available either in bare copper or with an additional plastic covering (Orange, Red or White).

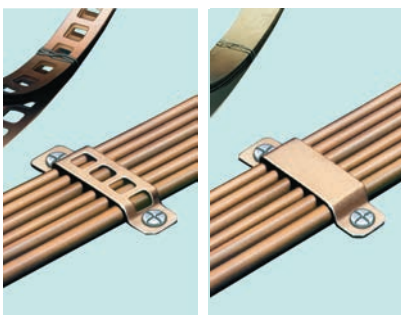

Reels

The popular Light Duty cable sizes are supplied as standard in 100 metre lengths on non-returnable reels as follows:



Cable sizes	2L1.5	2L2.5
Length metres	100	100
Type available	Bare Copper or LSF Outer Covered	
Colours available	Orange, Red or White	
Reel dimensions	400mm dia x 190mm width	
Reel Weight kg	Bare	LSF
	14.6	19.6

Coils

With the exception of the previous reel sizes, cable is supplied in coil form as standard.

The coil diameters are either 500mm, 915mm or 1370mm dependent on the cable diameter (for actual coil diameters and coil lengths please see pages 10 & 11.)

Drums

The following cables can be supplied ex-stock on non-returnable drums.

Cable size	Coil Length (approx) m.	LSF			Drum flange dia mm.
		Orange	Red	White	
2L1.5	500	■	■	□	750
2L2.5	500	■	■	□	750
3L1.5	500	■	■	□	750
4L1.5	500	■	■	□	750
4L2.5	490	■	■	□	1102
2H1.5	500	■	■	□	1102
2H2.5	420	■	■	□	1102
7L1.5	500	■	■	□	1102

NOTE:

In addition, all cables can be supplied in nominal coil lengths on free of charge non-returnable plywood drums.

For approximate lengths and weights of all cables please see pages 12 and 13. In instances where shorter lengths are required on drums an extra charge will be incurred.



United Kingdom

Tel: +0800 969 013
Fax: +0800 968 624
salesthermalUK@nVent.com

Ireland

Tel: +1800 654 241
Fax: +1800 654 240
salesIE@nVent.com

South East Asia

Tel: +86 21 2412 1688
Fax: +86 21 5426 3167
cn.thermal.info@nVent.com

Australia

Tel: +61 2 9751 8585

India - Noida

Tel: +91 120 464 9500
Fax: +91 120 464 9548
NTMinfome@nVent.com

India - Mumbai

Tel: +91 22 6775 8800/01
Fax: +91 22 6775 8997
NTMinfome@nVent.com

UAE

Tel: +971 4 823 8666
Fax: +971 4 887 0458
NTMinfome@nVent.com

Our powerful portfolio of brands:

CADDY ERICO HOFFMAN RAYCHEM SCHROFF TRACER



[nVent.com/PYROTENAX](https://www.nVent.com/PYROTENAX)