

WILDLIFE & ASSET PROTECTION CATALOG

Table of Contents

Wildlife & Asset Protection



BUS Insulation & Wildlife Protection 4

BUS Insulation
& Wildlife
Protection



Substations10

Substations

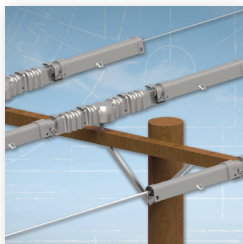

Overhead 22

Overhead

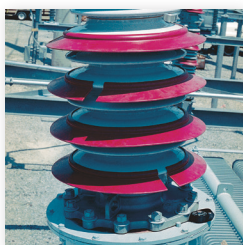

Contamination / Flashover Prevention..... 29

Contamination
Flashover
Prevention





BUS Insulation and Wildlife Protection

HVBT High Voltage Busbar Insulating Tape	4
BBIT / BPTM Busbar Insulating Tubing	6
HVIS High Voltage Busbar Insulating Sheet	7
RRBB Interphase Insulating Barrier Board	8
HVBC High Voltage Cable-to-Bus Insulation	9

HVBT High Voltage Busbar Insulating Tape

FEATURES

- Superior UV resistance
- Insulates up to 35 kV when two layers are applied at 2/3 overlap.
- Compatible with all other products in the TE's Raychem medium voltage insulation enhancement system
- Easy to apply using readily available equipment
- Suitable for both indoor and outdoor use
- Excellent anti-tracking properties
- Continuous operating temperature up to 90 °C
- Extremely versatile and flexible at temperatures as low as -40 °C, the 30% shrink ratio enables coverage of almost any shape
- Good thermal emissivity and contact with busbars means no derating is required
- Can be stored indefinitely at temperatures up to 50 °C without loss of performance

APPLICATIONS

- TE's Raychem HVBT tape offers a simple and effective solution to the problems of retrofit insulation of busbars, particularly where existing equipment cannot be dismantled.
- Can be used for indoor and outdoor applications and is easily installed over a wide variety of shapes, including complex connections.
- May be used in applications 15 kV in accordance with ANSI/IEEE specifications and up to 36 kV in accordance with IEC Specifications.

BENEFITS

- ♦ Protects against incidental/ accidental bridging caused by birds and animals.
- ♦ The HVBT adhesive layer fuses the tape layers, but does not stick to the bus or hardware, providing environmental sealing while allowing fast, easy removal
- ♦ Manufactured from non-halogen based materials, reducing the toxic and corrosive effects in the event of fire

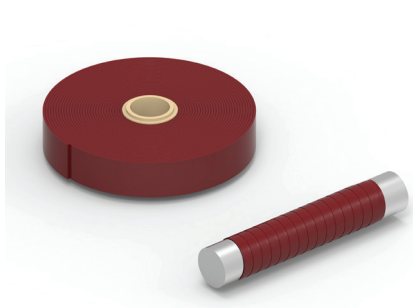

RECTANGULAR BUSBAR

Bus Width* in (mm)	Recommended Product	Bus Length Insulated per Roll feet (meters)
1 (25)	HVBT-1-R-01 (B8)	2.5 (0.7)
2 (50)	HVBT-2-R-01 (B4)	3.3 (1.0)
3 (75)	HVBT-2-R-01 (B4)	2.2 (0.6)
4 (100)	HVBT-2-R-01 (B4)	1.6 (0.5)
6 (150)	HVBT-2-R-01 (B4)	1.0 (0.3)
8 (200)	HVBT-4-R-01 (B2)	1.6 (0.5)

*Calculated with maximum thickness: 5/8 inch (15mm)



SQUARE BUSBAR

Dimensions of bar inch (mm)	Recommended Product	Bus Length Insulated per Roll feet (m)
1 x 1 (25)	HVBT-2-R-01 (B4)	4.0 (1.2)
2 x 2 (50)	HVBT-2-R-01 (B4)	2.0 (0.6)
3 x 3 (75)	HVBT-2-R-01 (B4)	1.3 (0.4)
4 x 4 (100)	HVBT-4-R-01 (B2)	2.0 (0.6)
6 x 6 (150)	HVBT-4-R-01 (B2)	1.3 (0.4)



ROUND BUSBAR

Busbar Diameter inch (mm)	Recommended Product	Bus Length Insulated per Roll feet (m)
0.5 (12)	HVBT-1-R-01 (B8)	5.0 (1.5)
1.0 (25)	HVBT-2-R-01 (B4)	5.0 (1.5)
2.0 (50)	HVBT-2-R-01 (B4)	2.5 (0.7)
3.0 (75)	HVBT-2-R-01 (B4)	1.5 (0.4)
4.0 (100)	HVBT-4-R-01 (B2)	2.5 (0.7)

PRODUCT SELECTION INFORMATION:

Catalog Number	Roll Width Roll Length	Standard Package
HVBT-1-R-01 (B8)	1 inch 25 feet	8 rolls/box
HVBT-2-R-01 (B4)	2 inches 25 feet	4 rolls/box
HVBT-4-R-01 (B2)	4 inches 25 feet	2 rolls/box

ADDITIONAL PRODUCT INFORMATION

- Select the appropriate catalog number for the application. Confirm selection with the following recommendations and TE's HVBT tape dimensions:
 - HVBT-1-R is best for short lengths and small bus sizes.
 - HVBT-2-R is the most versatile width for general purpose use.
 - HVBT-4-R is useful for long lengths and larger bus sizes.
- To environmentally seal the bus, order S1251-50-300-1 or S1251-25-300-4 sealant strips separately.
- Recommended application is to wrap the tape around the busbar using a two-thirds overlap.
- Bolted connections require two layers of tape.
- Continuous operating temperature: 90 degrees Celsius.
- Related Test reports: UVR-8023, EDR-5154, and EDR-5466

BBIT / BPTM Busbar Insulating Tubing

FEATURES

- TE's Raychem BBIT/BPTM tubes are extremely flexible which allows for easy positioning
- Have a high expansion ratio, so each size of tubing fits a range of busbar sizes
- Quick installation with the use of a gas torch or oven

APPLICATIONS

- Ideal for protection against accidental bridging caused by birds and other animals
- Can be used on straight or bent bars where clearance reduction or insulation are required
- Ideal for original equipment assembly, and for retrofit applications where access to one end is available

BENEFITS

- Easy installation
- Flexible
- Fits a range of busbar sizes
- Versatile tubing covering a range from 5-35 kV for electrical insulation

PRODUCT SELECTION INFORMATION: DIMENSIONS IN INCHES (MM)

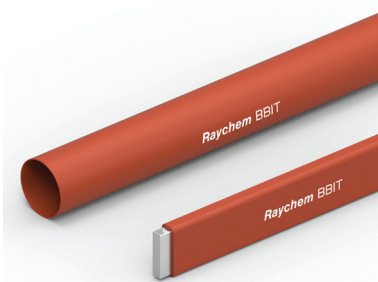

Catalog Number	Rectangular Bar (bus width)	Square Bar (each side)	Round Bar (diameter min-max)	Diameter as Supplied and Fully Recovered
BBIT-25/10-A/U	0.5 (12)		0.50-0.70 (12-18)	0.98-0.39 (25-10)
BBIT-40/16-A/U	1.0 (25)		0.70-1.10 (18-28)	1.57-0.63 (40-16)
BBIT-65/25-A/U	2.0 (50)	1.0 (25)	1.10-1.55 (28-40)	2.56-0.98 (65-25)
BBIT-100/40-A/U	3.0 (75)	2.0 (50)	1.75-2.45 (44-62)	3.94-1.57 (100-40)
BBIT-150/60-A/U	4.0 (100)	3.0 (75)	2.60-3.60 (66-91)	5.91-2.36 (150-60)
BBIT-175/80-A/U	5.0-6.0 (125-150)	4.0 (100)	3.45-4.75 (88-121)	6.89-3.15 (175-80)

Catalog Number*	Rectangular Bar		Square Bar		Round Bar		Diameter as Supplied and Fully Recovered
	5 - 15 kV	25 kV	5 - 15 kV	25 kV	5 - 15 kV	25 kV	
BPTM-15/6-A/U	N/A	N/A	N/A	N/A	0.26-0.52 (7-13)	0.26-0.52 (7-8)	0.59-0.24 (15-6)
BPTM-30/12-A/U(B50)	0.25-0.5 (12)		0.5 (12)	0.5 (12)	0.53-0.90 (14-23)	0.53-0.65 (14-16)	1.18-0.47 (30-12)
BPTM-50/20-A/U(B50)	1.0 (25)	1.0 (25)	1.0 (25)	N/A	0.90-1.35 (23-33)	0.90-1.10 (23-28)	1.97-0.79 (50-20)
BPTM-75/30-A/U(B50)	2.0 (50)	2.0 (50)	1.5 (38)	1.0 (25)	1.30-2.00 (33-51)	1.30-1.65 (33-42)	2.95-1.18 (75-30)
BPTM-100/40-A/U(B50)	3.0 (75)	3.0 (75)	2.0 (50)	1.5 (38)	1.75-2.75 (44-70)	1.75-2.30 (44-58)	3.94-1.57 (100-40)
BPTM-120/50-A/U(B50)	4.0-5.0 (100-127)	4.0 (100)	3.0 (75)	2.0 (50)	2.15-4.00 (55-102)	2.15-3.20 (55-81)	4.72-1.97 (120-50)
BPTM-175/70-A/U(B50)	6.0-7.0 (150-178)	5.0-6.0 (127-150)	4.0 (100)	3.0 (75)	3.20-5.50 (81-140)	3.20-4.40 (81-112)	6.88-2.75 (175-70)
BPTM-205/110-A/U(B50)	8.0 (200)	8.0 (200)	5.0 (127)	4.0 (100)	4.75-7.00 (120-178)	4.75-6.80 (120-174)	8.07-4.33 (205-110)
BPTM-235/130-A/U-C(40)	12 (300)	10 (250)	6.0 (150)	6.0 (150)	5.70-8.45 (145-215)	5.70-8.07 (145-205)	9.25-5.12 (235-130)

* (Bxx) denotes roll of uncoated tubing per box in feet. BPTM-235/130 comes in a box of 132 feet

ADDITIONAL PRODUCT INFORMATION

- Select the appropriate catalog number. Confirm selection with bus dimensions.
- Rectangular bus thickness range is 1/4 to 5/8 inch.
- Bolted connections require two layers of tubing or a fiber bolt pad. (BP-46).
- To environmentally seal the bus at each end of the BBIT tubing, order S1251-50-300-1 or S1251-25-300-4 sealant strip separately.
- Standard package:
BBIT-25/10-A/U: 65 feet/box BBIT-150/60-A/U: 50 feet/box
BBIT-40/16-A/U: 60 feet/box BBIT-175/80-A/U: 50 feet/box
BBIT-65/25-A/U: 50 feet/box BBIT-100/40-A/U: 50 feet/box
BPTM-235/130-A/U: 132 feet/box
All other BPTM sizes: 50 feet/box
BBIT and BPTM are also available in bulk spooled quantities.
- Related test reports:
BBIT-UVR-8136, UVR-8137, BPTM-UVR-8019
- Minimum continuous length is 15 feet (4.5 meters).

HVIS High Voltage Busbar Insulating Sheet

FEATURES

- TE's Raychem HVIS adhesive coated material provides insulation to Busbar/connections and does not adhere to metal.
- Compatible with other Wildlife and Asset Protection products or alone to prevent accidental bridging from birds and animals
- 5-15 kV

APPLICATIONS

- Busbar tees
- Busbar elbows
- Other complex Busbar shapes

BENEFITS

- Easy to install high performance insulation
- Product is UV resistant
- Made of anti-tracking material



PRODUCT SELECTION INFORMATION: DIMENSIONS IN INCHES (MM)

Catalog Number	Width	Length	Packaging
HVIS-05-(B3) NS	26 (660)	20 (508)	Sheet
HVIS-10-(B1) NS	26 (660)	33ft (10m)	Roll

SHEET (HVIS) ACCESSORIES

Catalog Number	Description	Standard Pack
HVIS-Flat (B12)	36" flat bracket for clamping HVIS on straight runs	12 each
HVIS-Angle (B12)	Angle brackets for clamping HVIS at 90 degree angles	12 each
HVIS-Clamp (B25)	Spring clamps to hold brackets on HVIS	25 each

Bus Width	Cut Size Needed	Number of Installations Per HVIS-05 Sheet	Number of Installations per HVIS-10 Roll
T Connection			
1 (25)	11 x 9 (275 x 225)	4	88
2 (50)	13 x 10 (325 x 250)	4	78
3 (75)	16 x 11 (400 x 275)	2	48
4 (100)	18 x 13 (450 x 325)	2	44
6 (150)	22 x 17 (550 x 425)	1	23
Elbow Connection			
1 (25)	11 x 7 (275 x 175)	4	112
2 (50)	13 x 9 (325 x 225)	4	88
3 (75)	15 x 10 (375 x 250)	2	52
4 (100)	18 x 11 (450 x 275)	2	44
6 (150)	22 x 13 (550 x 325)	1	36

ADDITIONAL PRODUCT INFORMATION

- Select the appropriate catalog number. Confirm selection with dimensions.
- Busbars are assumed to be insulated to within one inch of the joint. Cut size should extend a minimum of four inches onto each leg of the joint before shrinking.
- The above table should be used as a guide only; experiment to confirm final cut size. Table is based on 5/8-inch bus thickness period.
- To environmentally seal each leg of the bus, order S1251-50-300-1 or S1251-25-300-4 sealant strips separately.
- HVIS may be rated for applications up to 35kV when two layers are applied.
- Standard package:
HVIS-05: 3 sheets/box
HVIS-10: 1 roll/box
- Related test report: EDR-5175, EDR-5385

RRBB Interphase Insulating Barrier Board

FEATURES

- Non-structural, interphase barrier
- Made from homogeneous polymer
- Easily fabricated into a shape
- Innovative cross-linking resistant material can be wiped clean after power-arc events resulting in no visible effects or surface damage
- Machining properties allow it to be cut and drilled for mounting without requiring special safety equipment
- Extremely durable.

APPLICATIONS

- TE's Raychem RRBB protects switchgear cabinets against interphase flashovers
- UV Resistance makes it suitable for outdoor applications

BENEFITS

- ♦ Excellent track resistance, especially following a power arc
- ♦ Produces less nuisance dust than other boards
- ♦ Produces less tooling wear than other boards
- ♦ Extended life due to the excellent tracking resistant properties
- ♦ High durability makes boards resistant to damage from solvents, mechanical impact and general wear and tear



PRODUCT SELECTION INFORMATION: DIMENSIONS IN INCHES (MM)

Catalog Number	Width	Length	Thickness
RRBB-6-1.25Mx1.25M-(B3)	48 (1220)	48 (1220)	0.250 (6)
RRBB-2440/1220-6.2-BP	48 (1220)	96 (2440)	0.250 (6)

ADDITIONAL PRODUCT INFORMATION

Related Test Report: EDR-5311

HVBC High Voltage Cable-to-Bus Insulation

FEATURES

- Kit contains heat shrinkable insulating tubing and sealant strips for insulating and environmentally sealing high voltage in-line cable-to-busbar connections
- Kit contains heat shrinkable sealing boot for multiple cable connections

APPLICATIONS

- TE's Raychem HVBC kits are used with TE's high voltage terminations, the diameter build-up over the cable is minimal
- HVBC may be used in applications up to 15 kV in accordance with ANSI/IEEE specifications, and up to 36 kV in accordance with IEC applications

BENEFITS

- ♦ Kit greatly simplifies field installation and eliminates the labor and skill needed for tape-and-putty methods
- ♦ Increases working space in cramped areas and allows up to four cable connectors



PRODUCT SELECTION INFORMATION:

Catalog Number		Number of Cables	Cable Size Range (Min - Max)
Bus width: 2 - 4 inches	Bus width: 5 - 6 inches		
HVBC-41	HVBC-61	1	#4-1000 kcmil
HVBC-42	HVBC-62	2	#4-1000 kcmil
HVBC-43	HVBC-63	3	#4-1000 kcmil
HVBC-44	HVBC-64	4	#4-1000 kcmil

Accessory

BP-46	Fiberglass Bolt Pad (sleeve)
-------	------------------------------

ADDITIONAL PRODUCT INFORMATION

- Select the appropriate catalog number. Confirm selection with dimensions. One HVBC kit insulates one phase of an in-line cable-to-bus connection.
 - Maximum bolt length: 2 inches
 - Maximum busbar thickness: 5/8 inch
 - Maximum bare bus length: 9 inches
- BBIT tubing, BPTM tubing, or HVBT tape, can be used to insulate the exposed busbar before installing the HVBC products.
- Shielded cable must be terminated before installing the HVBC products; use TE's HVT terminations.
- Standard package: 3 kits/box
- Related test report: EDR-5103



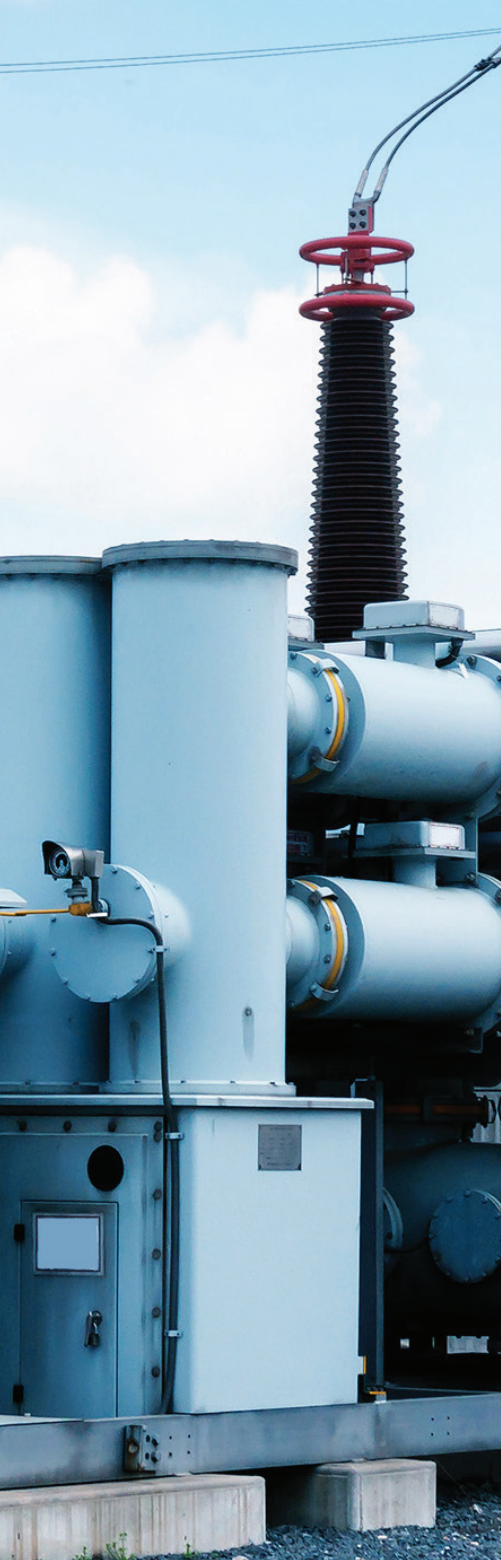

Substations

BISG / BISG-24 Bus Isolation Squirrel Guard	12
BCAC Bushing Connection Animal Covers	13
BCAC-IC Bushing Connection Inspection Substation Covers.....	14
BCIC Bushing Connection Insulating Covers	15
MVFT Medium Voltage Fusion Tape	22
MVCC Medium Voltage Conductor Covers.....	23
BCIC-Angle Medium Voltage Conductor Cover.....	23

BISG / BISG-24 Bus Isolation Squirrel Guard

FEATURES

- High voltage outdoor materials are used in the design
- Polymer is rugged, track resistant, UV-Stable, and ensures long-term performance regardless of environmental conditions
- Comes in red or gray colors
- Sizes range from two to five inches from the factory with "grill" design allowing for easy field modifications

APPLICATIONS

- TE's Raychem BISG is on installed substation equipment to protect animal caused outages.

BENEFITS

- ♦ The Isolation guard has reliably prevented animal-caused outages in electrical substation equipment for years
- ♦ Allow excellent visibility of switch blades and other components while providing resistance to power arcs and high winds
- ♦ Designed to allow one person to quickly and easily install with hot-sticks on vertical or horizontal mounted insulators

BISG-60/115-02

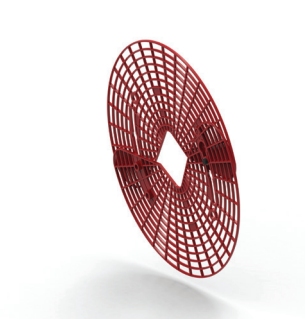

BISG-24



BISG-100/400

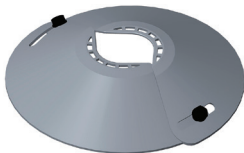

PRODUCT SELECTION INFORMATION: DIMENSIONS IN INCHES (MM)

Catalog Number	Insulator Core Diameter Range	Overall Product Diameter	Color	Installation
BISG-60/115-02(S10)	2.4-4.5 (60-115)	24	Red	De-energized
BISG-60/115-03-HOT (B10)	2.4-4.5 (60-115)	24	Red	Two stick (energized)
BISG-G-60/115-02(S10)	2.4-4.5 (60-115)	24	Gray	De-energized
BISG-G-60/115-03-HOT-B10	2.4-4.5 (60-115)	24	Gray	Two stick (energized)
BISG-24-01 (B10)	2.5-5.0 (62-125)	24	Red	One stick (energized)
BISG-G-24-01 (B10)	2.5-5.0 (62-125)	24	Gray	One stick (energized)
BISG-100/400 (B3)	1.50-4.50 (38-115)	16	Red	De-energized
BISG-G-100/400 (B3)	1.50-4.50 (38-115)	16	Gray	De-energized

ADDITIONAL PRODUCT INFORMATION

- Standard package: 10 BISG-60/115-02 | 10 BISG-24-01 assemblies per box. (one BISG will install on one insulator)
- Related test report: EDR-5310, EDR-5517-Bus Insulator Squirrel Guard (BISG-24-01)

BCAC Bushing Connection Animal Covers

FEATURES

- Specifically designed to prevent animal caused outages on bushing ranging from 15 to 35 kV
- Fast and easy installation
- Fit wide range of bushings and skirt diameters

APPLICATIONS

- TE's Raychem BCAC protects substation equipment from animal caused outages.

BENEFITS

- Preventing animal-caused outages for years
- Superior polymer provides long-term performance in all environments (material is rugged, non-tracking, and UV-Resistant)



PRODUCT SELECTION INFORMATION: DIMENSIONS IN INCHES (MM)

Catalog Number	Max Shed Diameter	Cover Height	Color
BCAC-5D/8-01(B12)	4.8 (122)	8.0 (203)	Red
BCAC-7D/10-01(B6)	6.8 (172)	10.5 (266)	Red
BCAC-8D/14-01(B6)	8.0 (203)	14.0 (355)	Red
BCAC-G-5D/8-01(B12)	4.8 (122)	8.0 (203)	Gray
BCAC-G-7D/10-01(B6)	6.8 (172)	10.5 (266)	Gray
BCAC-G-8D/14-01(B6)	8.0 (203)	14.0 (355)	Gray
BCAC-BYPASS-01(B1)*	6.8 (172)	10.6 (266)	Red
BCAC-BYPASS-02(B1)*	8.0 (203)	14.0 (355)	Red

* The BCAC covers are also kitted for voltage regulator applications. The kit includes two bushing covers and a center arrester cover.



ADDITIONAL PRODUCT INFORMATION

- Standard package: 12 or 6 units per box, depending on size of cover. (One BCAC will install on one insulator)
- Related Test Reports: EDR-5339, EDR-5407, UVR-8209

BCAC-IC Bushing Connection Inspection Substation Covers

FEATURES

- Visual inspection of connection and oil levels
- Conductors and leads exit easily through cover
- Robust latching and hinging mechanisms
- Reliable protection with enhanced features
- Good for coverage on equipment up to 35 kV

APPLICATIONS

- TE's Raychem BCAC-IC protects substation equipment from animal caused outages.

BENEFITS

- ♦ BCAC-IC Insulating covers prevent outages from all types of animals for years
- ♦ Fast and easy installation
- ♦ Top and side exits for conductor - no need to trim, therefore saving time



PRODUCT SELECTION INFORMATION: DIMENSIONS IN INCHES (MM)

Catalog Number	Standard Pack	Color	Insulator Core Range	Insulator Shed Range	Cover Size	
					Diameter	Height
BCAC-IC						
BCAC-IC-5D/6 (B6)	6	Red	1.5-3.5 (38-89)	2.5-5.0 (63-127)	5.00 (127)	6 (152)
BCAC-IC-7D/12 (B6)	6	Red	3.0-4.87 (76-124)	3.75-7.00 (95-178)	7.00 (178)	12 (305)
BCAC-IC-8D/18 (B6)	6	Red	3.5-6.25 (90-160)	4.00-8.00 (100-200)	8.00 (200)	18 (455)
BCAC-IC-10.5D/20 (B6)	6	Red	3.5-8.5 (90-215)	6-10.5 (150-267)	10.75 (273)	20 (508)
BCAC-G-IC-5D/6 (B6)	6	Gray	1.5-3.5 (38-89)	2.5-5.0 (63-127)	5.00 (127)	6 (152)
BCAC-G-IC-7D/12 (B6)	6	Gray	3.0-4.87 (76 24)	3.75-7.00 (95-178)	7.00 (178)	12 (305)
BCAC-G-IC-8D/18 (B6)	6	Gray	3.5-6.25 (90-160)	4.00-8.00 (100-200)	8.00 (200)	18 (455)
BCAC-G-IC-10.5D/20 (B6)	6	Gray	3.5-8.5 (90-215)	6-10.5 (150-267)	10.75 (273)	20 (508)

Catalog Number	Max Shed Diameter	Cover Height	Color
BCAC-IC-BYPASS			
BCAC-IC-BYPASS-01 (B1)	7.0 (178)	12.00 (305)	Red
BCAC-G-IC-BYPASS-01 (B1)	7.0 (178)	12.00 (305)	Gray

The BCAC covers are also kitted for voltage regulator applications. The kit includes two bushing covers and a center arrester cover.

ADDITIONAL PRODUCT INFORMATION

- Related test reports: EDR-5514, UVR-8209

BCIC Bushing Connection Insulating Covers

FEATURES

- Specifically designed to protect energized equipment conductors or busbars from flashovers from contact with birds, squirrels and other wildlife
- Variety of shapes and sizes protect a wide range of applications
- Excellent UV protection and track resistance

APPLICATIONS

- Substations
- Circuit breaker bushings
- Standoff insulators
- Capacitors
- Transformer bushings
- Voltage regulators
- Potential transformers

BENEFITS

- Long life span
- Installation can be done quickly in field by trimming entry and exit holes to required dimensions
- Can be re-entered for other maintenance needs and then reused, lowering overall lifetime costs

PRODUCT SELECTION INFORMATION: DIMENSIONS IN INCHES (MM)

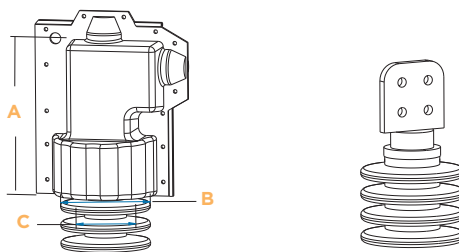
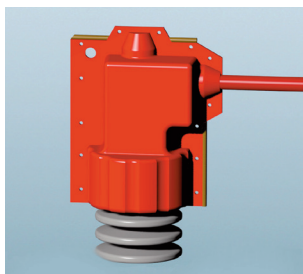

Catalog Number	Height (A)	Base Diameter (B)	Other Measurements (C)	Additional Notes
BCIC-4411 (B3)	10.6 (268)	6.0 (152)	4.0 (102) inner diam.	4 (100) Bottom port opening

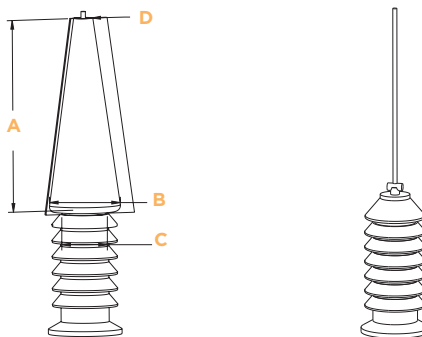

Catalog Number	Height (A)	Base Diameter (B)	Other Measurements (C)	Additional Notes
BCIC-SG-101-H2 (B3)	12 (305)	4.5 (114)	3 (72) inner diam.	(D) 1.125 (29) top diam. Bottom and top opening

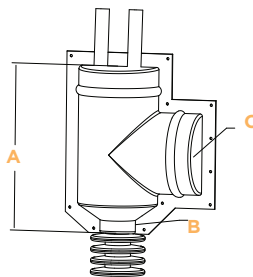
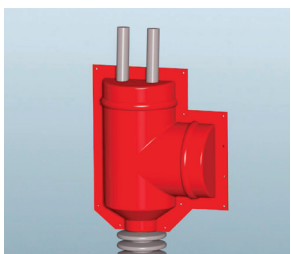

Catalog Number	Height (A)	Base Diameter (B)	Other Measurements (C)	Additional Notes
BCIC-9D/19-3 (B3)	18.5 (470)	4 (102)	9 (229) side diam.	

PRODUCT SELECTION INFORMATION: DIMENSIONS IN INCHES (MM)

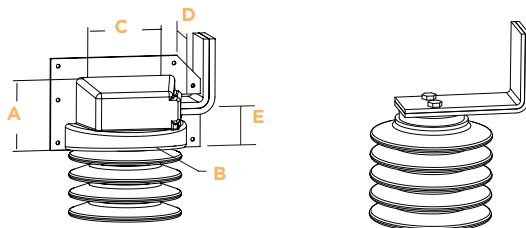
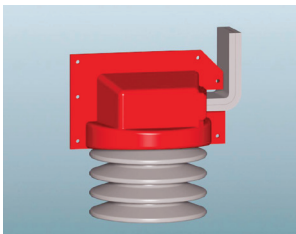

Catalog Number	Height (A)	Base Diameter (B)	Other Measurements (C)	Additional Notes
BCIC-8D/6-3 (B3)	4.7 (119.4)	8.0 (203.2)	5.00 (127) wide	(D) 5.40 (137.2) long, opening (E) 2.75 (69.9) from bottom

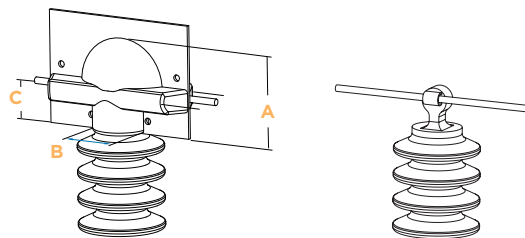
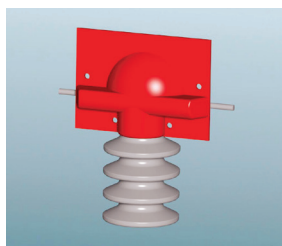

Catalog Number	Height (A)	Base Diameter (B)	Other Measurements (C)	Additional Notes
BCIC-3D/6-3 (B3)	3.5 (90.2)	2 (51)	1.5 (38) L. side diam.	2.0 (51) R. side opening 6.0 (152) width

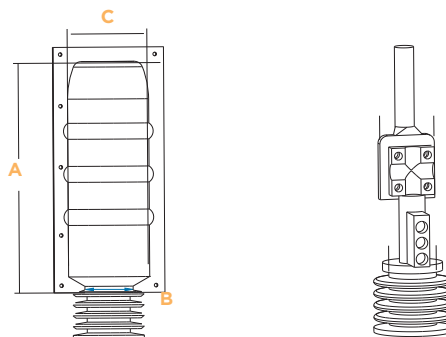

Catalog Number	Height (A)	Base Diameter (B)	Other Measurements (C)	Additional Notes
BCIC-5.5D/16-HO (B3)	17.1 (434)	3.2 (81)	5.5 (140) top diam.	

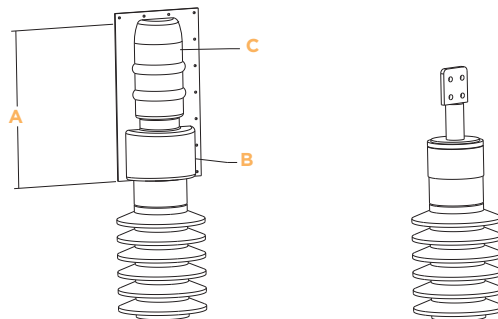
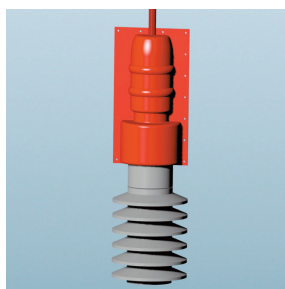

Catalog Number	Height (A)	Base Diameter (B)	Other Measurements (C)	Additional Notes
BCIC-8D/15-HO (B3)	16.2 (411)	8.0 (203.2)	5.5 (140) top diam.	4.5 (114) middle section diam., 12.5 height of section C.
BCIC-8D/18-HO (B3)	19.2 (488)	8.0 (203.2)	5.5 (140) top diam.	4.5 (114) middle section diam., 12.5 height of section C.

PRODUCT SELECTION INFORMATION: DIMENSIONS IN INCHES (MM)

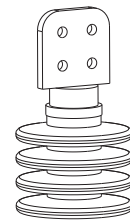
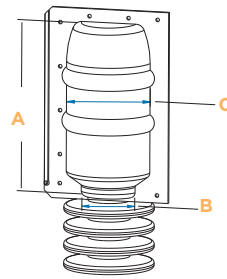
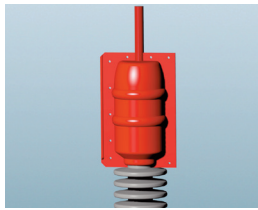

Catalog Number	Height (A)	Base Diameter (B)	Other Measurements (C)	Additional Notes
BCIC-5.5D/11-H0(B3)	11.5 (292)	3.50 (89)	5.50 (140) mid diam.	N/A

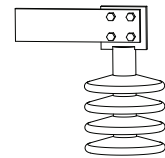
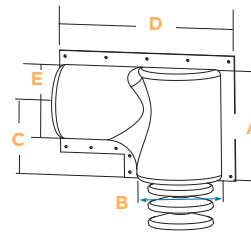
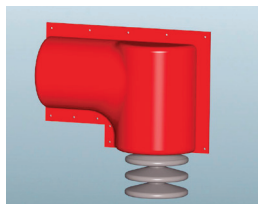

Catalog Number	Height (A)	Base Diameter (B)	Other Measurements (C)	Additional Notes
BCIC-10D/18-3 (B3)	14 (140)	9 (90)	7.75 (77.5)	(D)- 17.00 (E)- 8

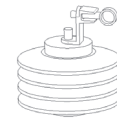
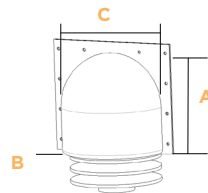
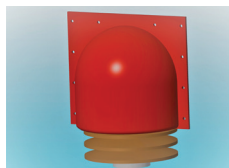

Catalog Number	Height (A)	Base Diameter (B)	Other Measurements (C)	Additional Notes
BCIC-8.25D/8	8 (80)	3 (30)	8.5 (85)	

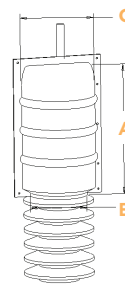
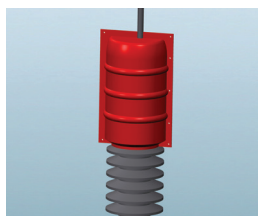

Catalog Number	Height (A)	Base Diameter (B)	Other Measurements (C)	Additional Notes
BCIC-10D/18 (B3)	18 (457.2)	10 (254)	7.7 (195.58)	Bottom Port opening

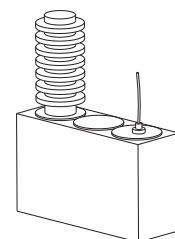
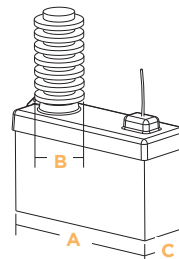
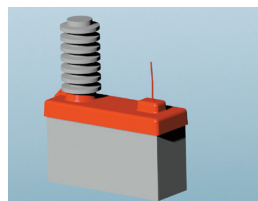

Catalog Number	(A)	Base Diameter (B)	Other Measurements (C)	Additional Notes
BCIC-0270-SCE (B3)	13.5 (135)	4.625 (117)	4.625 (46.25)	13.3 (338) length

PRODUCT SELECTION INFORMATION: DIMENSIONS IN INCHES (MM)

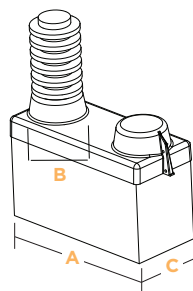
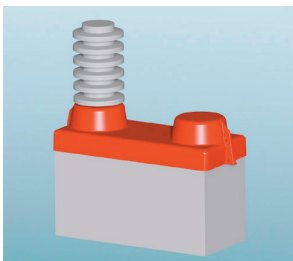

Catalog Number	(A)	Base Diameter (B)	Other Measurements (C)	Additional Notes
BCIC-0370-SCE (B3)	13.5 (mm)	3.63 (92)	5.875 (mm)	N/A

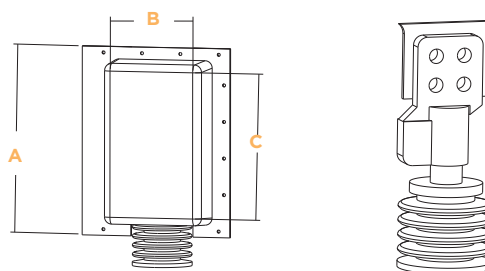
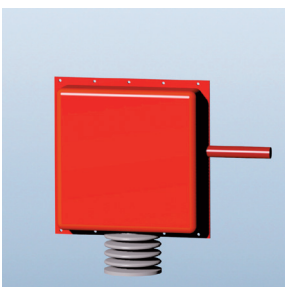

Catalog Number	Height (A)	Base Diameter (B)	Other Measurements (C)	Additional Notes
BCIC-12/12/5-H (B3)	12 (305)	12 (305)	5 (127)	N/A
BCIC-14/19/6-U (B3)	14 (356)	19 (483)	6 (142)	N/A
BCIC-24/11/12 (B3)	11 (279)	24 (610)	12 (304)	N/A
BCIC-4/12/4-H (B3)	4 (102)	12 (305)	4 (102)	N/A
BCIC-7/12/7-H (B3)	7 (178)	12 (305)	7 (178)	N/A
BCIC-4/16/4-H (B3)	4 (102)	16 (406)	4 (102)	N/A

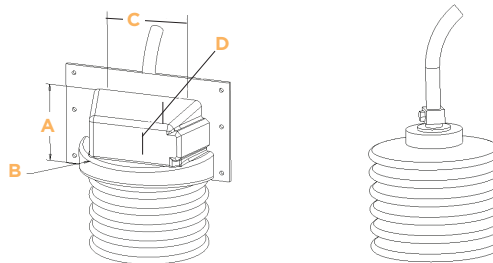
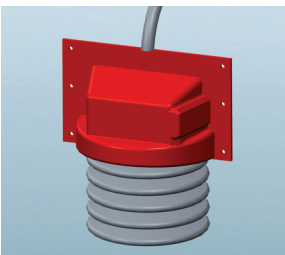

Catalog Number	Height (A)	Base Diameter (B)	Other Measurements (C)	Additional Notes
BCIC-8D/6 (B3)	4.8 (121.92)	8 (203.2)	6.5 (165.1) wide	(D)- 5.00 Supplied in two halves with no pre cut openings

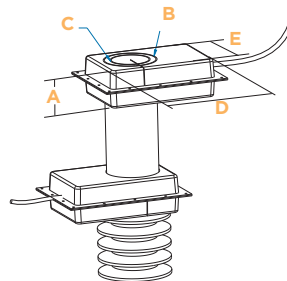
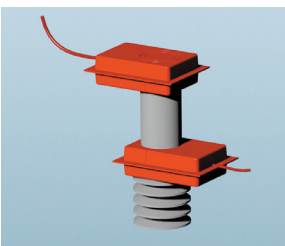

Catalog Number	Height (A)	Base Diameter (B)	Other Measurements (C)	Additional Notes
BCIC-8/12/2-U(B3)	4 (101)	5.75 (146.1)	4.25 (108) inner diam.	(D)- 12.0 (305) wide (E)- 8.0 (203) long

PRODUCT SELECTION INFORMATION: DIMENSIONS IN INCHES (MM)

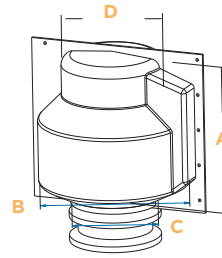
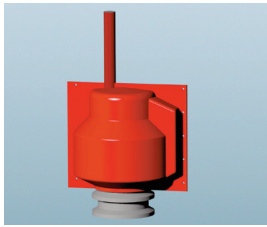

Catalog Number	Height (A)	Base Diameter (B)	Other Measurements (C)	Additional Notes
BCIC-13D/13-HO (B3)	13 (330)	13 (330)	7.5 (191) inner diam.	(D)- 8.8 (224) top diam.

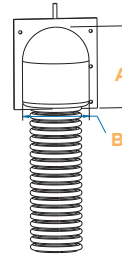

Catalog Number	Height (A)	Base Diameter (B)	Other Measurements (C)	Additional Notes
BCIC-5D/6 (B3)	6 (152)	5 (127)	N/A	N/A

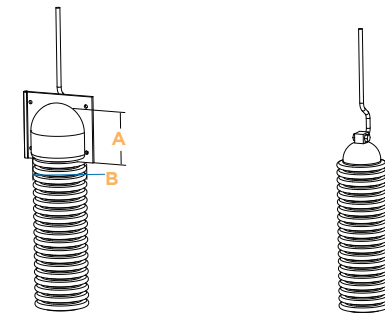
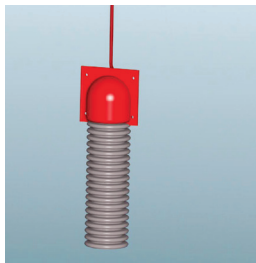

Catalog Number	Height (A)	Base Diameter (B)	Other Measurements (C)	Additional Notes
BCIC-4D/4 (B3)	4 (102)	4 (102)	N/A	N/A

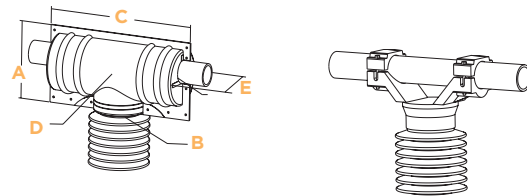
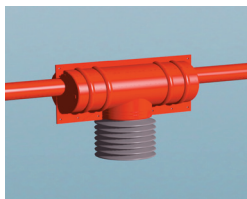

Catalog Number	Height (A)	Base Diameter (B)	Other Measurements (C)	Additional Notes
BCIC-7.5D/18-3 (B3)	10.4 (264)	4.5-6.75 (114-171)	20 (508) length	(D) 7.5 (191) L diam., (E) 2-4 (50-100) R diam.

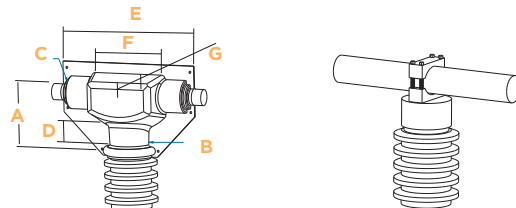

Catalog Number	Height (A)	Base Diameter (B)	Other Measurements (C)	Additional Notes
BCIC-SG-201-SCE(B3)	8.05 (204.5)	5.25 (133.4)	4.0 (102) Max side diam.	(D) 3.0 (76) base-joint height, (E) 17.5 (445) width (F) 8.25 (209.6) (G) 7.25 (184.2) depth

PRODUCT SELECTION INFORMATION: DIMENSIONS IN INCHES (MM)

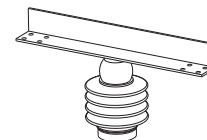
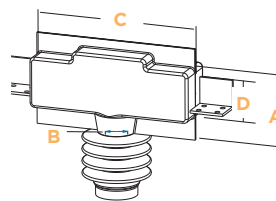
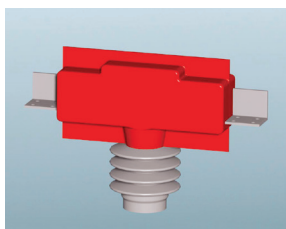

Catalog Number	Height (A)	Base Diameter (B)	Other Measurements (C)	Additional Notes
BCIC-TR205-L (B3)	7.5 (191)	2.25 (57)	17.0 (432) length	(D) 4.25 (108) side height

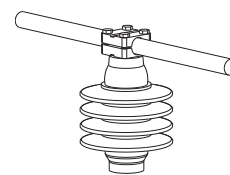
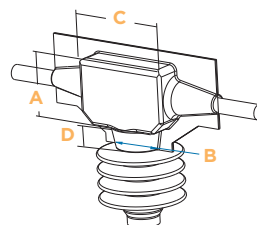
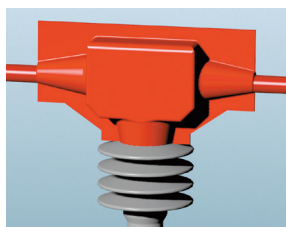

Catalog Number	Height (A)	Base Diameter (B)	Other Measurements (C)	Additional Notes
BCIC-TR205-R (B3)	5.5 (140)	4.5 (114)	8.0 (203)	(D) 2 (50) joint height

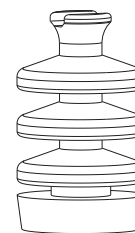
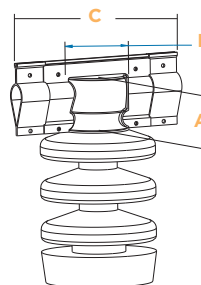
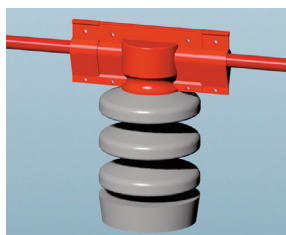

Catalog Number	Height (A)	Base Diameter (B)	Other Measurements (C)	Additional Notes
BCIC-3212-01 (B3)	3.5 (89)	4.125 (105)	12 (305) long	N/A

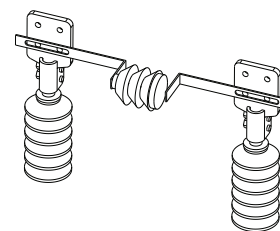
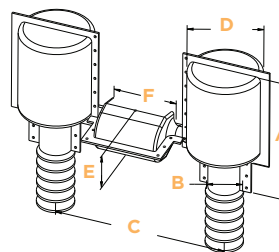
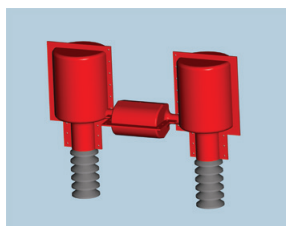

Catalog Number	Height (A)	Base Diameter (B)	Other Measurements (C)	Additional Notes
BCIC-BYPASS (B1)	13.75 (349.25)	3.75 (95.25)	19.00 (483) max distance	8.00 (203) top diam.,(D) 4.00 (102) connector diam., (E) 7.00 (178) (F) Design has two columns Connected with a cylinder

PRODUCT SELECTION INFORMATION: DIMENSIONS IN INCHES (MM)

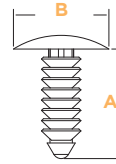

Catalog Number	Height (A)	Base Diameter (B)	Other Measurements (C)	Additional Notes
BCIC-LATCH (B250)	.800 (20.32)	.700 (17.78)	N/A	Std. Pack: 250 Latches or 1000 Latches

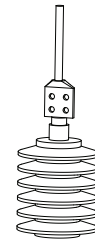
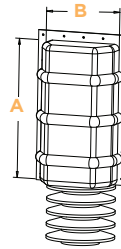
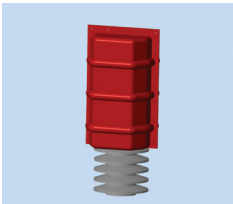

Catalog Number	Height (A)	Base Diameter (B)	Other Measurements (C)	Additional Notes
BCIC-11.5D/22(B3)	22 (559)	11.5 (292)	N/A	No pre trimmed openings

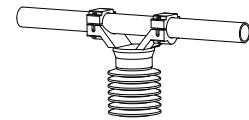
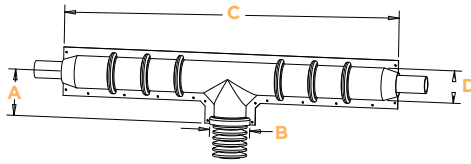
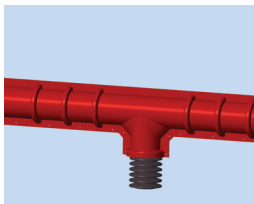

Catalog Number	Height (A)	Base Diameter (B)	Other Measurements (C)	Additional Notes
BCIC-5.5D/50	8 (200)	7 (178)	60 long (1524)	D- fits up to a 5.5" dia. bus

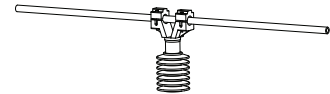
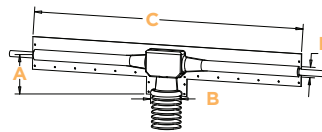
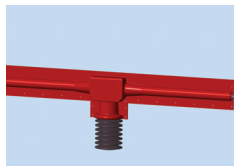

Catalog Number	Height (A)	Base Diameter (B)	Other Measurements (C)	Additional Notes
BCIC-5.5D/60(B4)	10.5 (267)	6.5 (165)	60 long (1524)	D- fits up to a 2" dia. bus

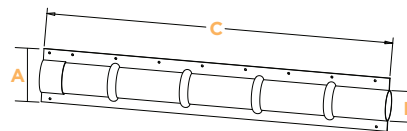
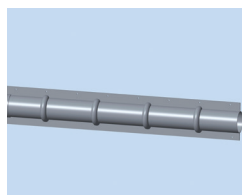

Catalog Number	Height (A)	Base Diameter (B)	Other Measurements (C)	Additional Notes
BCIC-G-4D/48-01(B4)	7.25 (184)	4 (101)	48 long (1219)	N/A

MVFT Medium Voltage Fusion Tape

FEATURES

- Self amalgamating
- Designed to combine the integrity of silicone polymer with the versatility of a wraparound product
- MVFT will stick to itself and other insulating materials, but will not adhere to metal or porcelain

APPLICATIONS

- TE's Raychem MVFT retrofit insulation of busbars
- Insulation when existing equipment can not be dismantled
- Suitable for indoor and outdoor use

BENEFITS

- ♦ Quick and easy to install
- ♦ Over-lapped layers amalgamate together, producing a complete seal
- ♦ A single layer of MVFT tape, two-thirds overlapped, will provide flashover protection to at least 15 kV and increases to 35 kV if second layer is added
- ♦ Selective sticking allows for easy removal for maintenance

MVFT



PRODUCT SELECTION INFORMATION

Catalog Number	Color	Width UOM: Inches (mm)	Length per Roll Feet (m)	Std. Pack
MVFT-G-2-12 (B4)	Gray	2 (50)	36 (11)	4 rolls



RECTANGULAR BUSBAR

Bus Width inches (mm)	Bus Length Insulated per Roll 2/3 Overlap feet (m)
1.0 (25)	8 (2.4)
2.0 (50)	4.7 (1.4)
3.0 (75)	3.1 (0.9)
4.0 (100)	2.3 (0.7)
6.0 (150)	1.4 (0.4)
8.0 (200)	0.4 (0.1)



ROUND BUSBAR

Bus Width inches (mm)	Bus Length Insulated per Roll 2/3 Overlap feet (m)
0.5 (12)	12.9 (3.9)
1.0 (25)	7.2 (2.2)
2.0 (50)	3.6 (1.1)
3.0 (75)	2.2 (0.7)
4.0 (100)	2.0 (0.6)



SQUARE BUSBAR

Bus Width inches (mm)	Bus Length Insulated per Roll 2/3 Overlap feet (m)
1x1 (25)	5.7 (1.7)
2x2 (50)	2.8 (0.8)
3x3 (75)	1.9 (0.6)
4x4 (100)	1.7 (0.5)

ADDITIONAL PRODUCT INFORMATION

- EDR-5465 Medium Voltage Fusion Tape Qualification Report

MVCC Medium Voltage Conductor Covers

FEATURES

- Made from non-tracking silicone material
TE's Raychem MVCC is suitable for harsh medium voltage outdoor environments
- Covers are split for easy installation
- Four sizes available which fit conductor diameters ranging up to 1.75 inch

APPLICATIONS

- Substation
- Suitable for up to 25 kV phase to ground

BENEFITS

- ♦ Provide high quality electrical insulation for substation leads and jumpers
- ♦ Flexibility allows installation on tight bends
- ♦ Specifically designed to prevent flashover caused by contact with birds and animals

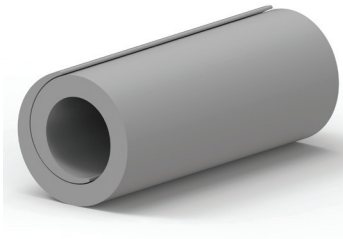

PRODUCT SELECTION INFORMATION

Catalog Number	Conductor Diameter Use Range UOM: inches (mm)	Color	Supplied Length UOM: feet (M)
MVCC-10/.40 (B100)	up to .450 (11)	Red	2 pieces at 50 (15.24)
MVCC-G-10/.40 (B100)	up to .450 (11)	Gray	2 pieces at 50 (15.24)
MVCC-19/.75 (B50)	0.50-0.75 (12-19)	Red	2 pieces at 25 (7.6)
MVCC-G-19/.75 (B50)	0.50-0.75 (12-19)	Gray	2 pieces at 25 (7.6)
MVCC-25/1.0 (B25)	0.75-1.125 (19-28)	Red	1 piece at 25 (7.6)
MVCC-G-25/1.0 (B25)	0.75-1.125 (19-28)	Gray	1 piece at 25 (7.6)
MVCC-45/1.75 x 4 (B24)	1.125-1.75 (28-44)	Red	6 pieces at 4 (1.2)
MVCC-G-45/1.75 x 4 (B24)	1.125-1.75 (28-44)	Gray	6 pieces at 4 (1.2)

ADDITIONAL PRODUCT INFORMATION

^a EDR-5461 Medium voltage Conductor Cover Electrical Testing and EDR-5498 Material test

BCIC-Angle Medium Voltage Conductor Cover

FEATURES

- Modular/ Wraparound product design
- Retrofit insulation on 3 to 4 inch angle busbars
- Insulation when existing equipment cannot be dismantled

APPLICATIONS

- TE's Raychem BCIC-Angle BUS Cover is suitable for indoor and outdoor use

BENEFITS

- ♦ Quick and easy to install
- ♦ Over-lapped sections together, produce increased bus bar coverage
- ♦ The BCIC angle bus cover will provide flashover protection up to 35 kV.



PRODUCT SELECTION INFORMATION

Catalog Number	Color	Busbar in (mm)	Supplied Length feet	Standard Pack pieces
BCIC-ANGLE-4X48 (B6)	Red	3-4 (75-100)	4	6
BCIC-G-ANGLE-4X48 (B6)	Gray	3-4 (75-100)	4	6

ADDITIONAL PRODUCT INFORMATION

- EDR-5594 BCIC-ANGLE-4X48 Electrical Testing

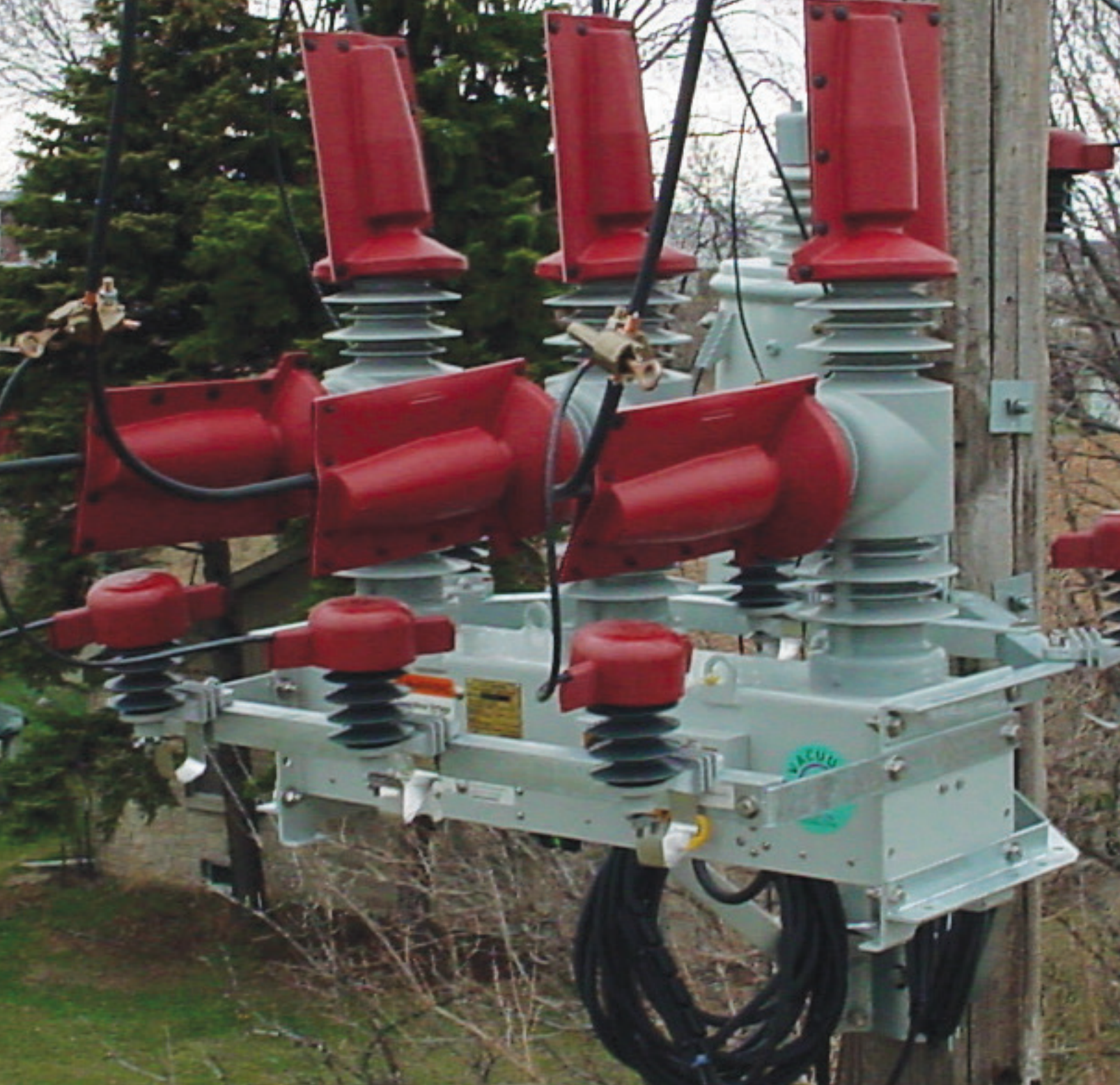



Overhead

BCIC Raptor Protection Cover	26
BCIC-GT Raptor Protection Cover	27
BCAC Distribution Covers for Animal Protection	28
BCIC Reclosers Recloser Covers	29
MVLC Medium Voltage Line Cover	30
BCIC-115-PH Transmission Flashover Protection Cover.....	32
BCIC-AFD-01 Avian Flight Diverter	32

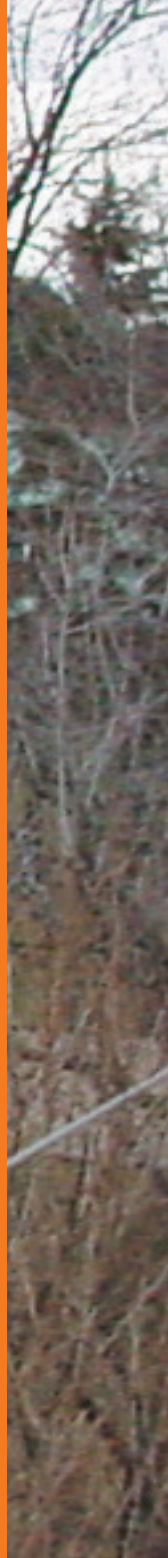

BCIC Raptor Protection Cover

FEATURES

- Reliable outage protection
- Fast and versatile installation
- High performance material
- Rugged, non-tracking, UV-resistant polymer
- Long-term performance in extreme conditions

APPLICATIONS

- TE's Raychem BCIC raptor protection covers protect overhead insulators to prevent outages caused by birds.

BENEFITS

- ♦ TE's Raychem BCIC insulating covers have a long history of successful outage prevention and these covers are designed to provide the same great protection with additional features
- ♦ Designed to nest over vibration dampers

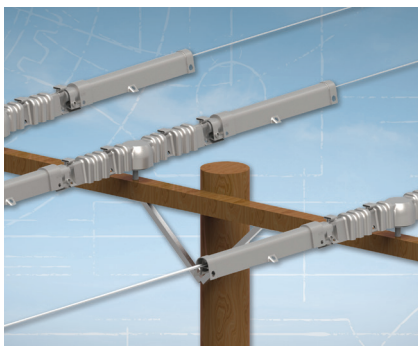

PRODUCT SELECTION INFORMATION

Catalog Number	Application	Conductor Range	Cover Length (in)	Type/ANSI	Standard Pack
BCIC-G-DPIN-795-01 (B6)	Double PIN Insulator	#6-795	41	55-5, 55-6, 55-7, 56-1, 56-2, 56-3	6
BCIC-G-DPIN-556-01 (B6)	Double PIN Insulator	#6-556	42	55-2, 55-3, 55-4, 55-5	6
BCIC-G-DSMPIN-795-01 (B6)	Double PIN Insulator	#6-795	42	55-5, 55-6, 55-7, 56-1, 56-2, 56-3	6
BCIC-G-HZ-795-XL (B6)	Horizontal Post	#6-795	29	Polymeric	6
BCIC-G-HZPOR/3.5D-795-01 (B6)	Horizontal Post	#6-795	29	Porcelain >35 kV	6
BCIC-G-HZPOR/4.5D-795-01 (B6)	Horizontal Post	#6-795	29	Porcelain 25 to 35 kV	6
BCIC-G-DE/CL-01 (B6)	Dead End	#6-795	27	Conductor	6

ADDITIONAL PRODUCT INFORMATION

- Related Test Reports: EDR-5562, EDR-5369

BCIC-GT Raptor Protection Cover

FEATURES

- Reliable outage protection
- Fast and versatile installation
- High performance material
- Rugged, non-tracking, UV-resistant polymer
- Long-term performance in extreme conditions

APPLICATIONS

- TE's Raychem BCIC-GT raptor protection covers protect overhead insulators to prevent outages caused by birds.

BENEFITS

- ♦ TE's Raychem BCIC-GT insulating covers have a long history of successful outage prevention and these covers are designed to provide the same great protection with additional features
- ♦ Up to 10 feet of coverage on conductor sizes ranging from #6 to 795 can be achieved when one cover and two arms are installed together
- ♦ Designed to nest over vibration dampers



BCIC-GT-PIN (B6)



BCIC-GT-PIN/CT (B6)

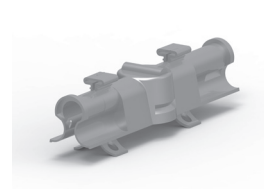

BCIC-GT-PIN/XL (B6)

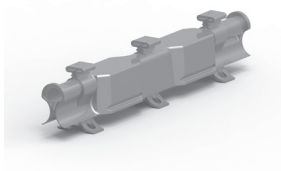

BCIC-GT-DPIN (B6)

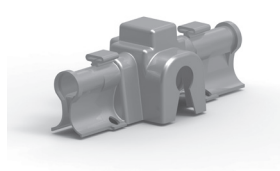

BCIC-GT-HZ (B6)

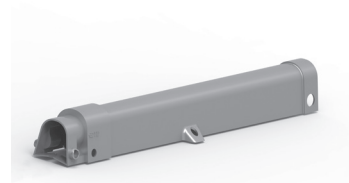

BCAC-G-ARM-01 (B12)

PRODUCT SELECTION INFORMATION

Description	Application	Range	Length (in)	Insulator Type/ANSI	Standard Pack
BCIC-GT-PIN (B6)	Porcelain Pin, Post	#6-795	20	55-4, 55-5, 57-2	6
BCIC-GT-PIN/CT (B6)	Vise Top	#6-795	20	Vise Top, Hendrix	6
BCIC-GT-PIN-XL (B6)	Porcelain Pin	#6-795	21	56-1, 55-6, 55-7	6
BCIC-GT-DPIN (B6)	Porcelain Pin, Post	#6-795	30.5	55-4, 55-5, 57-2	6
BCIC-GT-HZ (B6)	Horizontal Post	#6-795	21	Polymeric	6
BCAC-G-ARM-01 (B12)	Extension	#6-795	31	-	12

ADDITIONAL PRODUCT INFORMATION

- Related Test Report: EDR-5620 Salt Fog and Electrical Evaluation,
- EDR-5609 Raptor Cover Mechanical/Electrical Evaluation

BCAC Distribution Covers for Animal Protection

FEATURES

- TE's Raychem BCAC covers wide range of sizes
- Advanced polymers are rugged, track resistant, UV resistant

APPLICATIONS

- Terminations
- Reclosures
- Lightning arresters
- Fuse Cut-outs

BENEFITS

- ♦ Extensive testing has ensured that the cover will not damage or deteriorate the terminations
- ♦ Can be installed on energized equipment
- ♦ Secured to the stud and the conductor to insure protection even in high winds
- ♦ The BCAC-G-CUTOUT is hot-stickable and easily clips onto cutout insulators between first and second skirt

BCAC-AR-5D-2

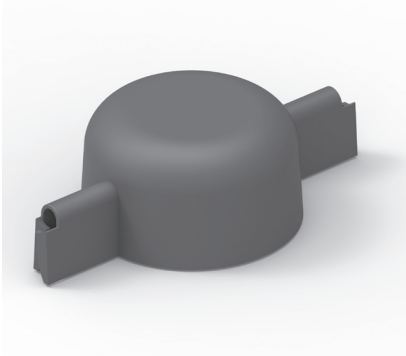

PRODUCT SELECTION INFORMATION

Catalog Number	Hardware
BCAC-P-IC-5D/6 (B6)	Transformer Bushing
BCAC-G-4D/13-2 (B18)	Terminations
BCAC-G-5D/8-01 (B12)	Transformer Bushing
BCAC-G-AR-5D-2 (B24)	Ohio Brass Arrester
BCAC-G-AR-4D-2 (B24)	TE Arrester
BCAC-G-AR-3.75D-2 (B24)	Cooper Arrester
BCAC-G-CUTOUT-100-01-B12	Fuse Cutout Switch (100 AMP) Porcelain style
BCAC-G-CUTOUT-100-P2-B12	100-AMP/Polymeric (Hubbel & Cooper style)
BCAC-G-CUTOUT-FT (B3)	Fuse Cutout Switch (200 AMP) Porcelain style
BCAC-G-CUTOUT-FT-P (B3)	Fuse Cutout Switch (200 AMP) Polymeric style



BCAC-4D/13-2



BCAC-P-IC-5D/6

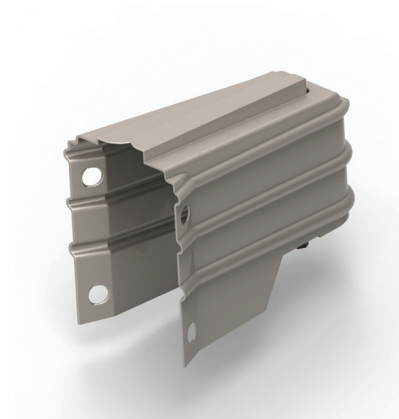

BCAC-G-CUTOUT-100-01

ADDITIONAL PRODUCT INFORMATION

- Related test reports: EDR-5407 for Bushing covers, EDR-5569 for BCAC-P-IC, EDR-5571 for BCAC-AR, EDR-5573 for cutouts

BCIC Reclosers Recloser Covers

FEATURES

- One piece hinged design allows easy and quick installations
- Cover can be re-entered for maintenance needs and then reused
- Rated for up to 35kV

APPLICATIONS

- Reclosers

BENEFITS

- ♦ Other TE Raychem products can be purchased that insulate the leads and lightning arresters
- ♦ Years of reliable service and re-usable design lowers overall lifetime costs

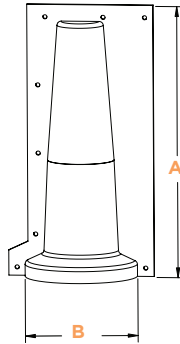

BCIC-G-Recloser-100 (B6)

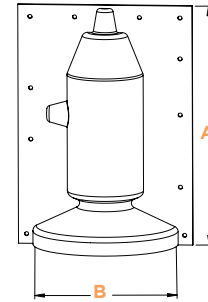

BCIC-G-Recloser-200 (B6)

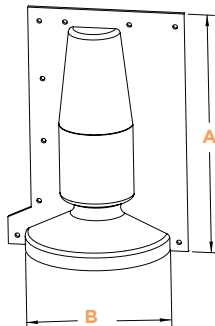

BCIC-G-Reclosercover (B6)

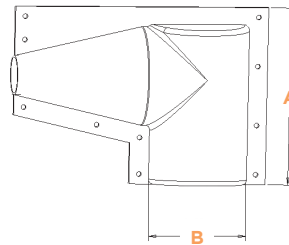

BCIC-5D/8/11 (B6)

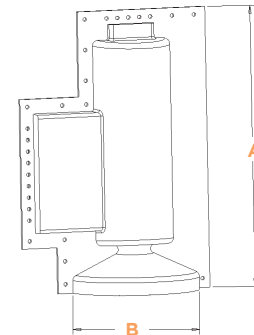

BCIC-Reclosure-200s (B6)

PRODUCT SELECTION INFORMATION: DIMENSIONS IN INCHES (MM)

Catalog Number	Color	Height (A)	Max Skirt (B)
BCIC-G-Reclosercover (B6)	Gray	12.4 (315)	7.8 (198)
BCIC-G-Recloser-100 (B30)	Gray	15.4 (390)	6.75 (171)
BCIC-G-Recloser-200 (B6)	Gray	14.5 (368)	8.5 (216)
BCIC-Reclosercover (B6)	Red	12.4 (315)	7.8 (198)
BCIC-Recloser-100 (B6)	Red	15.4 (390)	6.75 (171)
BCIC-Recloser-200S (B6)	Red	18.3 (465)	8.3 (211)
BCIC-G-Recloser-200S (B6)	Gray	18.3 (465)	8.3 (211)
BCIC-5D/8/11 (B6)	Red	9.0 (228)	4.8 (122)

MVLC Medium Voltage Line Cover

FEATURES

- Wrap-around cover
- Installation is possible on energized lines utilizing the MVLC tool which can be manually or automatically operated

APPLICATIONS

- Overhead conductors

BENEFITS

- ♦ Prevents electrical outages caused by incidental contact from tree branches or wildlife
- ♦ Can be applied selectively on problem spans to avoid costly conductor replacement

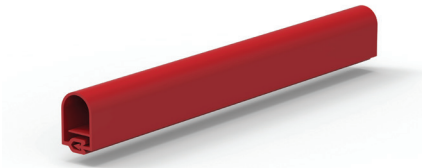

PRODUCT SELECTION INFORMATION: DIMENSIONS IN INCHES (MM)

Product Size	Conductor Size	Max. Conductor Dia.	Voltage Class
MVLC-14-A/U-C(100)	#6-3/0 kcmil	0.5 (12.7)	15 kV
MVLC-14-A/241-C(100)	#6-3/0 kcmil	0.5 (12.7)	25 kV (sealing mastic in receptacle)
MVLC-18-A/U-C(75)	#2-397 kcmil	.75 (18)	15 kV
MVLC-18-A/241-C(75)	#2-397 kcmil	.75 (18)	25 kV (sealing mastic in receptacle)
MVLC-38R-A/U-C (50)	#2-1590 kcmil	1.375 (35)	15 kV
MVLC-38R-A/241-C (50)	#2-1590 kcmil	1.375 (35)	25 kV (sealing mastic in receptacle)

MVLC-14

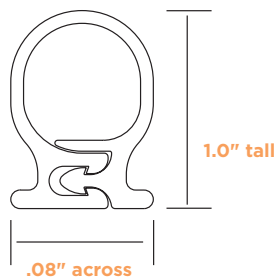

MVLC-18



MVLC-38R

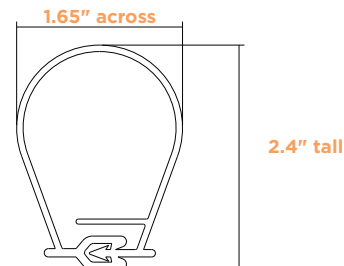

MVLC-Installation Tools for overhead conductors



MVLC-HAND-TOOL-14



MVLC-HAND-TOOL-02

Product Size	Conductor Size
MVLC-14-TOOL-100	for use with MVLC-14
MVLC-18-TOOL-03-2006	for use with MVLC-18
MVLC-38R-OHTOOL	for use with MVLC-38R
MVLC-HAND-TOOL-14	hand tool for installing MVLC-14
MVLC-HAND-TOOL-02	hand tool for installing MVLC-18
MVLC-38R-HAND TOOL	hand tool for installing MVLC-38R

ADDITIONAL PRODUCT INFORMATION

- Overhead Conductors: Standard package for MVLC-14 is 330 feet (100m) continuous on a spool. Standard package for MVLC-18 is 247 feet (75m) continuous on a spool.
- Related Test Reports: EDR-5308, EDR-5309, EDR-5316, EDR-5478
- MVLC TOOL contains the MVLC installation tool, MVLC cutters, drainage hole punch, hand crank, and a drive nut socket packaged in a protective bag
- MVLC can be installed at temperatures above 0°C (32°F)

PRODUCT PERFORMANCE

Test		MVLC-A/U / MVLC-A/241 (Sealed)	
AC withstand (dry) - 1minute		15 kV min / 25 kV min	
AC withstand (wet) - 1 minute		15 kV min / 25 kV min	
AC long term withstand (dry) - 4 hours		8.6 kV min / 14.4 kV min	
30 day thermal loading (8 hr at 130°; 16 hr off)		No MVLC deformation	
Conductor ampacity		82 - 89% of bare conductor ampacity	
Material Properties Per pps 3010/42		Test Method	Requirement
Physical	Tensile Strength Ultimate Elongation Abrasion Resistance Low Temperature Impact	ASTM D638 ASTM D638 1000 cycles, 2068g ASTM D746	8 Mpa min 1150 psi min 200% min 20% max thickness loss No Cracking at -20°C
Electrical	Dielectric Strength Tracking and Erosion Resistance	ASTM D149 ASTM D2303 Step Voltage Method (Initiate at 2.5 kV)	217 kV/cm @ 1.27 mm 550 V/mil min @ 0.050" No tracking or erosion to top surface or flame failure after: 200 minutes

BCIC-115-PH Transmission Flashover Protection Cover

FEATURES

- TE's Raychem BCIC-115-PH can be used on both porcelain disc and polymeric insulator designs
- Unique design allows the cover to rest on the lowest insulator for porcelain i-string designs
- Made from robust BCIS high-voltage material that is rugged, non-tracking, and UV-Resistant polymer

APPLICATIONS

- 115 kV transmission lines

BENEFITS

- Long-term performance even in the most extreme environmental conditions
- Can be used on energized or de-energized installations

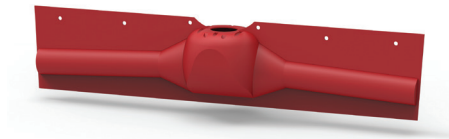

PRODUCT SELECTION INFORMATION: DIMENSIONS IN INCHES (MM)

Catalog Number	Length	Height	Insulator Range	Applications
BCIC-115-PH (B1)	74 (1879.6)	15 (381)	9 12 (229-305)	Main cover
BCIC-Collar-50/280-5-B				Adapter collar for polymeric installations

BCIC-AFD-01 Avian Flight Diverter

FEATURES

- TE's Raychem BCIC-AFD-01 is designed to prevent bird collisions with power lines
- Incorporates high reflectivity and "glow-in-the-dark" appliques
- Easy to install, Hot-stickable, removeable
- Made from robust BCIC polymer that is rugged, non-tracking and UV resistant

APPLICATIONS

- Distribution and transmission lines

BENEFITS

- Long-term performance even in the most extreme environmental conditions
- Can be used on energized or de-energized installations



PRODUCT SELECTION INFORMATION: DIMENSIONS IN IN(MM)

Catalog Number	Description	Dimensions W x H	Conductor Size	Standard Pack
CU7208-000	BCIC-AFD-01 (B10)	4 x 3.5 (102 - 89)	#6-795	10

ADDITIONAL PRODUCT INFORMATION

- EDR-5536, Rev. A

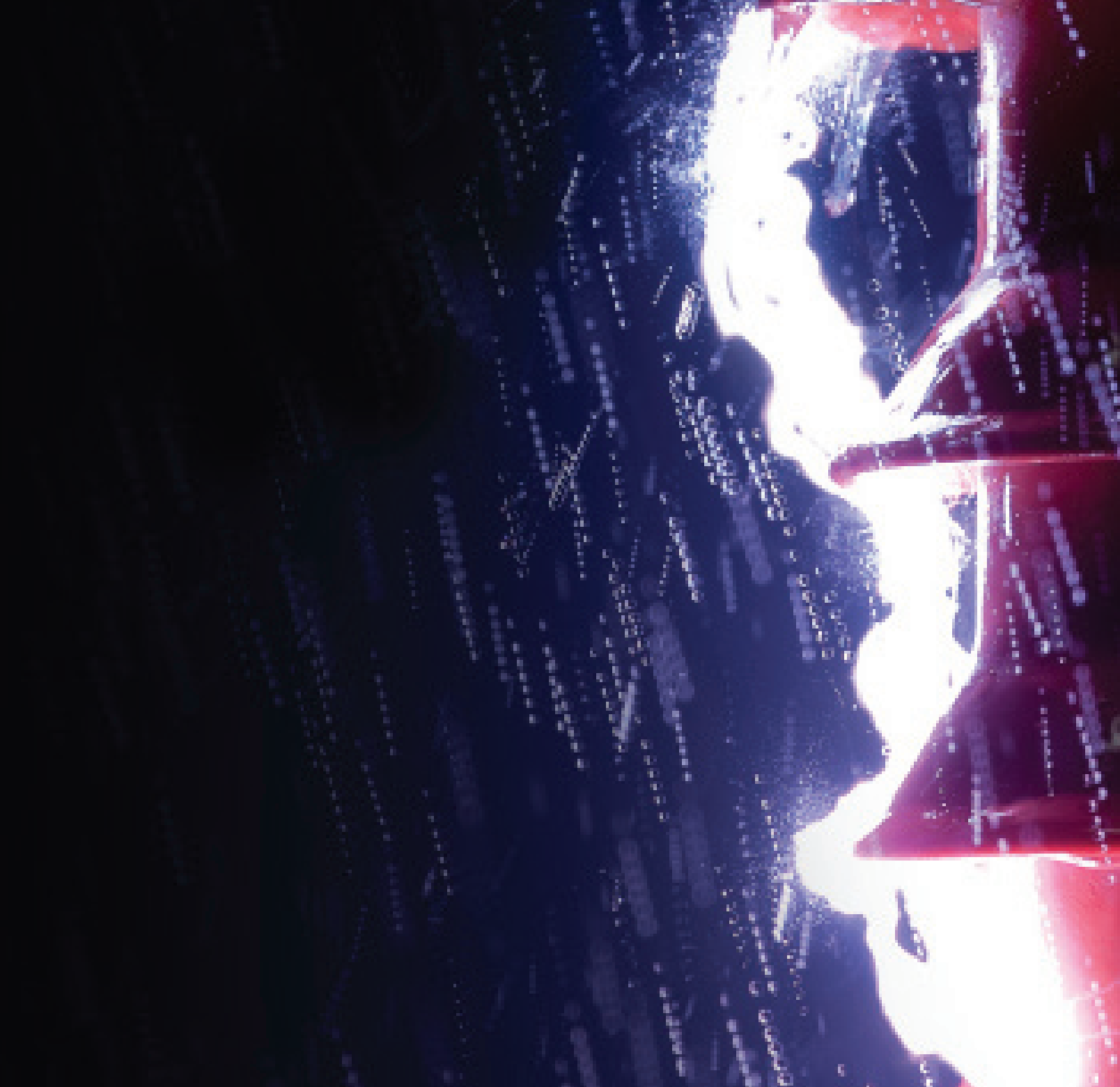



Contamination/ Flash Prevention

HVCE High Voltage Creepage Extenders	36
HVCE-WA Wraparound High Voltage Creepage Extenders.....	37
HVBS High Voltage Booster Shed	38
RRGS Polymeric and Porcelain Rigid Red Guano Shield	38
Protection, Repair and Maintenance	39
Protection of Outdoor Equipment	39
Protection of Medium Voltage Products	40
Bus Insulation Technical Data	41

HVCE High Voltage Creepage Extenders

FEATURES

- TE's Raychem HVCE high voltage creepage extenders are heat shrinkable
- Resistant to conventional spray washing techniques
- Will withstand most normal handling, abuse, and extreme weather conditions

APPLICATIONS

- Insulators

BENEFITS

- ♦ Increases the flashover performance of insulators by reducing the surface electrical stress and leakage current and increasing the electric strength of the insulators

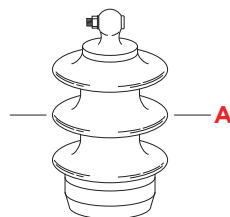

PRODUCT SELECTION INFORMATION: DIMENSIONS IN INCHES (MM)

Catalog Number	Skirt Diameter of Insulator (Min-Max) (A)	Minimum Internal Diameter of HVCE (as supplied)	Creepage Extension Per Extender (mm)	Standard Pack (pcs/box)
HVCE 100/80-01 (B-6)	3.20-3.90 (81-99)	4.50 (114)	101.6	6
HVCE 120/100-01 (B-6)	3.90-4.70 (99-119)	5.30 (135)	101.6	6
HVCE 140/120-01 (B-6)	4.70-5.50 (119-140)	6.10 (155)	101.6	6
HVCE 160/140-01 (B-6)	5.50-6.30 (140-160)	7.00 (178)	101.6	6
HVCE 183/161-01 (B-6)	6.30-7.20 (160-183)	8.00 (203)	101.6	6
HVCE 205/184-01 (B-6)	7.20-8.10 (183-206)	9.00 (229)	101.6	6
HVCE 226/206-11 (B3)	8.10-8.90 (206-226)	9.40 (239)	101.6	3
HVCE 247/227-11 (B3)	8.90-9.70 (226-246)	10.30 (262)	101.6	3
HVCE 268/248-11 (B3)	9.70-10.50 (246-267)	11.10 (282)	101.6	3
HVCE 289/269-11 (B3)	10.50-11.40 (267-290)	11.90 (302)	101.6	3
HVCE 310/290-11 (B3)	11.40-12.20 (290-310)	12.70 (323)	101.6	3
HVCE 331/311-11 (B3)	12.20-13.00 (310-330)	13.60 (345)	101.6	3
HVCE 352/332-11 (B3)	13.00-13.90 (330-353)	14.40 (366)	101.6	3
HVCE 373/353-11 (B3)	13.90-14.70 (353-373)	15.20 (386)	101.6	3
HVCE 394/374-11 (B3)	14.70-15.50 (373-393)	16.10 (409)	101.6	3

ADDITIONAL PRODUCT INFORMATION

- Select the appropriate catalog number. Confirm selection with insulator skirt outer diameter (A)
- Each HVCE extender adds a nominal 4 inches to the creepage length. As a general recommendation, TE advises a 20 percent increase in existing creepage distance. Use this formula to calculate the number of creepage extenders needed: Existing creepage distance in inches x 0.2 / 4 = Minimum number of HVCE creepage extenders recommended (i.e., 40 inches creepage x 0.2 / 4 = 2 HVCEs needed). Always round up to a whole number (i.e., 1.33 to 2 HVCE's)
- For applications that do not fall within the ranges above, contact your local TE representative
- HVCE does not upgrade the voltage class of the insulator.
- Related test reports: UVR-8138, UVR-8144, UVR-8037, EDR-5350

HVCE-WA Wraparound High Voltage Creepage Extenders

FEATURES

- TE's Raychem HVCE-WA creepage extender has a wrap-around product design
- Adds six inches of creepage length

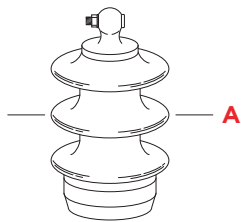
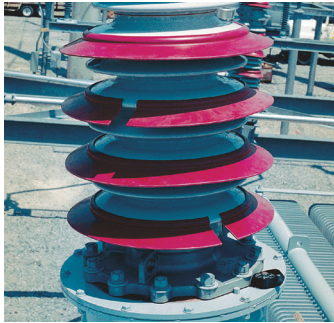

Example of a typical cross section of an HVCE with the dimensions representing that of the insulator profile

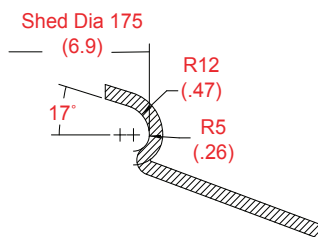

APPLICATIONS

- Insulators

BENEFITS

- Installs without having to disconnect equipment/conductors
- For use in highly contaminated applications

PRODUCT SELECTION INFORMATION: DIMENSIONS IN INCHES (MM)

Catalog Number	Shed Diameter of Insulator (A)	Standard Pack
HVCE-WA-175-02-FT (B6)	6.90 (175)	6
HVCE-WA-206-01 (B6)	8.11 (206)	6
HVCE-WA-216-01 (B6)	8.50 (216)	6
HVCE-WA-221-01 (B6)	8.70 (221)	6
HVCE-WA-226-01 (B6)	8.90 (226)	6
HVCE-WA-227-01 (B6)	8.94 (227)	6
HVCE-WA-234-01 (B6)	9.21 (234)	6
HVCE-WA-244-01-FT (B6)	9.61 (244)	6
HVCE-WA-248-01 (B6)	9.76 (248)	6
HVCE-WA-251-01 (B6)	9.88 (251)	6
HVCE-WA-255-01 (B6)	10.04 (255)	6
HVCE-WA-267-01 (B6)	10.51 (267)	6
HVCE-WA-271-01 (B6)	10.67 (271)	6
HVCE-WA-280-01-FT (B6)	11.02 (280)	6
HVCE-WA-281-01 (B6)	11.06 (281)	6
HVCE-WA-287-01 (B6)	11.30 (287)	6
HVCE-WA-292-01 (B6)	11.50 (292)	6
HVCE-WA-303-01 (B6)	11.93 (303)	6
HVCE-WA-323-01 (B6)	12.72 (323)	6
HVCE-WA-326-01 (B6)	12.83 (326)	6
HVCE-WA-330-01 (B3)	13.00 (330)	3
HVCE-WA-336-01 (B6)	13.23 (336)	6
HVCE-WA-341-01 (B6)	13.39 (341)	6
HVCE-WA-348-01 (B6)	13.70 (348)	6
HVCE-WA-349-01 (B6)	13.74 (349)	6
HVCE-WA-356-01 (B6)	14.02 (356)	6
HVCE-WA-359-01 (B6)	14.13 (359)	6
HVCE-WA-364-01 (B6)	14.33 (364)	6
HVCE-WA-367-01 (B6)	14.45 (367)	6
HVCE-WA-372-01 (B6)	14.65 (372)	6
HVCE-WA-373-01 (B6)	14.68 (373)	6
HVCE-WA-377-01 (B6)	14.84 (377)	6
HVCE-WA-381-01 (B6)	15.00 (381)	6
HVCE-WA-392-01 (B6)	15.43 (392)	6
HVCE-WA-393-01 (B6)	15.47 (393)	6
HVCE-WA-406-01 (B6)	15.98 (406)	6
HVCE-WA-407-01 (B6)	15.98 (407)	6
HVCE-WA-413-01 (B6)	16.26 (413)	6
HVCE-WA-421-01 (B6)	16.54 (421)	6
HVCE-WA-426-01 (B6)	16.77 (426)	6
HVCE-WA-429-01 (B6)	16.89 (429)	6
HVCE-WA-440-01 (B6)	17.32 (440)	6
HVCE-WA-442-01-FT (B6)	17.40 (442)	6
HVCE-WA-452-01 (B6)	17.60 (452)	6
HVCE-WA-457-01 (B6)	18.00 (457)	6
HVCE-WA-463-01 (B6)	18.23 (463)	6
HVCE-WA-482-01 (B3)	18.98 (482)	3
HVCE-WA-488-01 (B6)	19.21 (488)	6
HVCE-WA-490-01 (B6)	19.29 (490)	6
HVCE-WA-501-01 (B6)	19.72 (501)	6

ADDITIONAL PRODUCT INFORMATION

- Each HVCE-WA Extender adds six inches to the creepage length. As a general recommendation, TE advises a 20 percent increase in existing creepage distance. Use this formula to calculate the number of creepage extenders needed:
Existing creepage distance in inches x 0.2 / 6 = Minimum number of HVCE creepage extenders recommended. (i.e., 60" x .2 / 6 = 2 HVCE-WAs needed). Always round up to a whole number (i.e., 1.33 - 2 HVCE's needed).
- HVCE does not upgrade the voltage class of the insulator
- Related Test Reports: UVR-8152, EDR-5350 Related Installation Instructions: HVCE-WA
- Installation Tool: HVCE-WA-TOOL
- For Applications that do not fall within the ranges above, contact your TE representative.

HVBS High Voltage Booster Shed

FEATURES

- Spacers and short pegs which separate it from the porcelain skirt and insulator core
- TE's Raychem HVBS booster shed is a wrap around for rapid installation

APPLICATIONS

- Circuit breaker bushings
- Bus support insulators
- Surge arresters
- Transformer bushings

BENEFITS

- ♦ Prevents "Heavy Wetting" and ice-cascade-induced flashovers
- ♦ Made with advanced UV-resistant and anti-tracking polymer



PRODUCT SELECTION INFORMATION: DIMENSIONS IN INCHES (MM)

Catalog Number	Suitable Insulator Core	Medium Outside Insulator Skirt	Booster Shed Diameter Fully Installed
HVBS-770/310-01-M-BP	8.9-10.1 (227-257)	12.0 (304)	28.1 (713)
HVBS-740/280-01-M-BP	7.8-9.0 (199-229)	10.9 (276)	27.0 (685)
HVBS-710/250-01-M-BP	6.9-7.9 (175-201)	9.8 (249)	25.9 (657)
HVBS-685/225-01-M-BP	6.2-7.0 (158-178)	9.3 (235)	25.0 (634)
HVBS-665/205-01-M-BP	5.5-6.3 (140-160)	8.5 (216)	24.3 (616)
HVBS-615/155-01-M-BP	3.7-4.5 (94-114)	6.3 (161)	22.4 (569)

ADDITIONAL PRODUCT INFORMATION

- Related Test Report: UVR-8107 Qualification report for Booster Sheds
- Please contact your TE sales team for other available sizes.

RRGS Polymeric and Porcelain Rigid Red Guano Shield

FEATURES

- TE's Raychem RRGs is designed to fit both porcelain bells and polymeric insulators
- Two piece design allows for quick installation

APPLICATIONS

- Vertical insulator strings

BENEFITS

- ♦ Protects insulators from bird streamers



PRODUCT SELECTION INFORMATION: DIMENSIONS IN INCHES

Catalog Number	Insulator Type	Shield Diameter
RRGS-35/470-FT (B12)	Polymeric	18
RRGS-35/600-FT (B3)	Polymeric	24
RRGS-35/470-M (B12)	Porcelain	18
RRGS-35/600-M (B12)	Porcelain	24

Gray color also available

Protection, Repair and Maintenance

TE's Raychem Wildlife and Asset Protection product family offers easy-to-install busbar insulation systems for both the field engineer and the manufacturer. These electrical insulation products provide flashover protection against the accidental bridging of conductors commonly caused by birds and animals.

The system is ideal for both enclosed and exposed bus work and for connections in switchgear lineups, substations, and other electrical apparatus. It also permits clearance reduction in many applications.

Excellent Electrical and Thermal Performance

TE's Raychem Wildlife and Asset Protection products are manufactured from high dielectric strength, radiation-crosslinked, heat shrinkable materials. The high-voltage materials are specially formulated to provide high resistance to arcing and tracking. All high-voltage and low-voltage materials provide high-thermal endurance throughout the range of switchgear operating temperatures. They offer field-proven reliability and long service life in harsh environments. In addition, these heat shrink tubing, tape, and sheet products can be preformed and pre-shrunk in the customer's shop, allowing easy, quick installation in the field.

Compatibility with Other Insulating Materials

All Wildlife and Asset Protection heat shrinkable electrical insulation products are compatible with other solid switchgear insulating materials. Electrical insulating materials are not subject to stress crazing or embrittlement and are not adversely affected by common plasticizers used in conventional switchgear insulating materials.

Flame-retardant Materials

Most Wildlife and Asset Protection heat shrinkable electrical insulating materials pass the ANSI C37.20 switchgear insulation flammability tests.

Reduced Corrosive and Toxic Fumes

Wildlife and Asset Protection electrical insulation materials contain no chlorine compounds. This minimizes noxious and corrosive effects in case of equipment fault or fire.

For Protection, Repair, and Maintenance

Wildlife and Asset Protection heat shrinkable electrical insulating tubes, tapes, and sheets provide a complete system for electrical repair and maintenance of enclosed or exposed buswork and for connections in switchgear and electrical equipment. They offer:

- Fast, easy installation and removal
- A flexible system to cover most conductor shapes and sizes
- Consistent, reliable installation
- Consistent electrical and thermal performance
- Proven corrosion protection
- Compatibility with conventional solid insulating materials
- Protection against flashovers

For the Electrical Equipment Manufacturers

The Wildlife and Asset Protection system of insulation-enhancement components addresses the needs of electrical equipment manufacturers. The superior material properties and versatility of these components enhance the quality and reliability of the final product. Wildlife and Asset Protection electrical insulating materials feature.

- Low-hazard formulation
- Flexibility
- Track resistance
- Rugged, easy installation
- Excellent electrical and thermal performance
- Unlimited shelf life
- Corrosion protection of conductor
- TE assistance and support for testing and applications

Protection of Outdoor Equipment

TE's Raychem Wildlife and Asset Protection electrical insulation products provide a complete system of insulation enhancement for high-voltage busbars and related equipment in outdoor substations and overhead lines. The system offers:

- Easy installation in the field
- Insulation for many different shapes, including busbars, joints, tees, insulators/bushing connections
- Flashover protection against accidental bridging
- Protection of wildlife and from wildlife-induced outages
- Excellent UV and weathering resistance
- Protection against corrosion
- Protection against incidental tree branch contact

Protection of Medium Voltage Products

Material Properties	Test Method	Requirements	BBIT/BPTM	BCIC/HVIS	BCAC, HVCE-WA, HVBT	HVCE	MVLC	BISG/RRBB
Test and Performance								
Volume Resistivity	ASTM D-257, IEC 93	ohm-cm min	1.0 x 10 ¹³	1.0 x 10 ¹³	1.0 x 10 ¹³	1.0 x 10 ¹³	1.0 x 10 ¹³	1.0 x 10 ¹³
Dielectric Constant	ASTM D-150, IEC 250	Maximum	5	5	5	5	5	5
Dielectric Strength	ASTM D-149, IEC 243	V/mil at 1.3mm min V/mil at 1.5mm min V/mil at 2mm min V/mil at 2.5mm min V/mil at 3mm min	500 450 400 350	330	330	250	550	V/mil at 2.5mm min: 380
Thermal								
Thermal Endurance	IEEE 1-1969, IEC 216	minimum	105°C	105°C	105°C**	110°C	105°C	
Accelerated Aging for 168 Hours	ISO 188	Tensile strength Ultimate elongation	1450 psi 300%	1450 psi 300%	1450 psi 300%	1100 psi 300%	1450 psi 100%	2450 psi 25%
		Aging Temperature	120°C	120°C	120°C	120°C	120°C	120°C
Chemical								
Flammability	ANSI C37.20	Pass	Pass	Pass	Pass			
Water Absorption	ISO/R 62, Procedure A	1% max after 14 days at 23°C	Pass	Pass	Pass	Pass	Pass	Pass
Low-Temperature Flexibility	ASTM D-2671, Procedure C	No cracking after 4 hours	Pass, -40°C	Pass, -40°C	Pass, -40°C	Pass, -40°C	Pass, -20°C	Pass, -40°C
Corrosion	Copper Mirror, ASTM D-2671, Procedure B	Passed visual inspection after 16 hours		Pass, 150°C	Pass, 150°C		Pass, 135°C	
Physical								
Tensile Strength	ASTM D-638, ISO 37	psi. (min)	1450 < 4mm 1150 > 4mm	1450	1450	1150	1450	2450
Ultimate Elongation	ASTM D-638, ISO 37	% minimum	300	300	300	300	200	25

NOTE :

Blank spaces indicate that property was not measured during product qualification

*Each product's voltage rating will be displayed with its selection information

**Properties measured on backing material only. HVBT has a 90°C maximum continuous operating temperature limit

Bus Insulation Technical Data

TABLE BACKGROUND

This table indicates clearance differences for rectangular busbars without and with various wildlife and asset protection electrical insulation products. These spacings are derived from BIL, AC-withstand, DC-withstand, and discharge-extinction tests on a limited number of busbar configurations insulated with electrical insulation products.

Due to the wide range of possible busbar geometries, these spacings should not be adopted without actual testing by the user. Sharp electrodes and unusual geometries will require greater spacings.

Note: Phase-to-phase distances are reduced more than phase-to-ground distances because it is assumed that each phase is insulated

BUSBAR DATA INFORMATION: DIMENSIONS IN IN(MM)

System Voltage (kV)	BIL (kV)	Uninsulated Clearance (Indoor)		BBIT Clearance (Indoor)		BPTM, HVBT, and HVIS Clearance (Indoor)	
		A*	B**	A*	B**	A*	B**
15	95	7.5 (190)	5.0 (125)	2.2 (55)	2.6 (65)	3.4 (85)	4.2 (105)
25	125	10.5 (265)	7.5 (190)	2.8 (70)	4.0 (100)	4.5 (115)	6.0 (150)
35	150	12.5 (320)	9.5 (240)	5.6 (140)	7.5 (190)	6.5 (165)	8.0 (200)

* Phase-to-phase

** Phase-to-Ground

RECOMMENDED GUIDE SPECIFICATION

Please feel free to use the following in your design specification:

Insulation for energized bus components and connections shall consist of tubing, tape, and sheets that are factory-engineered to meet applicable switchgear performance requirements.

All insulation components shall be fabricated from flexible, cross-linked, heat-shrinkable polymeric materials formulated to provide high dielectric strength, adequate thermal endurance at bus operating temperatures, and tracking and erosion resistance.

The insulation materials shall contain no halogen compounds and be compatible without commercial, factory-installed bus insulation materials.

Materials shall be installable at temperatures as low as -40°F. Adhesive coatings on tape and sheet products shall not adhere to metal surfaces, thus permitting easy re-entry to the connections.

The insulation supplier shall furnish technical data to document design and performance to these requirements and functional testing of the complete insulation system in accordance with ANSI/IEEE C37.20.

TE Connectivity (NYSE: TEL) is a \$12 billion global technology leader. Our connectivity and sensor solutions are essential in today's increasingly connected world. We collaborate with engineers to transform their concepts into creations - redefining what's possible using intelligent, efficient and high-performing TE products and solutions proven in harsh environments. Our 75,000 people, including 7,300 design engineers, partner with customers in close to 150 countries across a wide range of industries. We believe EVERY CONNECTION COUNTS - www.TE.com.

- Mining
- Nuclear power plants
- OEM
- Petrochemical plants
- Railway
- Substations
- Transmission
- Distribution
- Windfarms
- Solar
- Hydro-electric
- Commercial/Industrial
- Telecom/Datacom
- Lightning Protection

WHEREVER ELECTRICITY FLOWS, YOU'LL FIND TE CONNECTIVITY

te.com/energy

FOR MORE INFORMATION:

TE Technical Support Centers

USA/Canada: +1 800 327 6996
Mexico: +52 0-55-1106-0800
South America: +57 1-319-8962

te.com/energy

©2019 TE Connectivity Corporation. All Rights Reserved. IP-CAT-0001-WAP AMS-03-19-EN
AMP, AMPACT, SHEAR-LOK, WRENCH-LOK, TE Connectivity and TE connectivity (logo) are trademarks. COPPERWELD is a trademark of Copperweld Bimetallics, LLC. Other logos, product and Company names mentioned herein may be trademarks of their respective owners. While TE has made every reasonable effort to ensure the accuracy of the information in this catalog, TE does not guarantee that it is error-free, nor does TE make any other representation, warranty or guarantee that the information is accurate, correct, reliable or current. TE reserves the right to make any adjustments to the information contained herein at any time without notice. TE expressly disclaims all implied warranties regarding the information contained herein, including, but not limited to, any implied warranties of merchantability or fitness for a particular purpose. The dimensions in this catalog are for reference purposes only and are subject to change without notice. Specifications are subject to change without notice. Consult TE for the latest dimensions and design specifications.