

SIGNAL CONVERTER OF THE PREMIUM CLASS

MULTI-FUNCTIONAL
COMPONENT



SINEAX V604s



SIGNAL CONVERTER OF THE PREMIUM CLASS

SINEAX V604s is a high-performance intelligent signal converter unit with a very high basic accuracy of 0.1 %.

However, SINEAX V604s is more than a simple isolation amplifier or temperature transmitter.

The instrument may be adapted to the most varied measuring tasks via the MODBUS/RTU interface integrated as a standard and the CB-Manager software available free-of-charge.

This multifunctionality in combination with very easy operation results in a wide range of applications of classical tasks, e.g. temperature measurement or signal isolation through to intelligent monitoring tasks aligned to safety.

SINEAX V604s is characterised by the following features:

- Sensor connection without any external jumpers
- High-quality pluggable screw terminals or spring cage terminal
- 2 analogue inputs and 2 analogue outputs
- 2 relay outputs *
- Digital output (SO) *
- Digital MODBUS/RTU interface for parameterising and system integration
- Integrated mathematical functions
- Functions for safety-aligned measurements
- Integrated DC energy meter *
- Customised linearisation
- Numerous limit value monitoring and alarms
- AC/DC wide-range power supply unit

ONE INSTRUMENT – NUMEROUS FUNCTIONS

INTEGRATION OF SIGNALS (DC ENERGY METER) *

- The input variables or the calculated variables of SINEAX V604s can be integrated via time.
- A physical unit can be allocated to each input signal
- Each unit may be freely scaled

SAFE MEASUREMENT AND ANALYSIS

- Highly precise measurements at 2 inputs
- Safety-aligned measurement by redundant temperature measurement
- Mathematical linking of both inputs

SIGNAL AMPLIFICATION

- Signals are amplified by SINEAX V604s and transferred without any losses

REMOTE I/O FUNCTIONALITY *

- Outputs can be accessed independent of the input via MODBUS
- Relays can be controlled via MODBUS

PROTECTION OF PERSONS AND PLANTS

- Galvanic isolation between input, output, power supply and bus
- Measurement up to 300 V DC according to overvoltage Category III *
- Measurement up to 600 V DC according to overvoltage Category II *



LIMIT VALUE MONITORING

- 4 limit values + 1 alarm *
- 2 relays (changer) *
- Digital output (SSO) *
- Monitoring of Speedchanges over time (Gradient)

COMMUNICATION

- MODBUS/RTU interface
- 2 analogue outputs *
- 1 or 2 relays *
- Digital output (SO) *

SIGNAL ADAPTATION AND CONVERSION

- Stored characteristic curve for TC, RTD, cylindrical horizontal tank
- User-specific characteristic curve with up to 24 basic values in free allocation of the X and Y coordinates

* Depending on the type of instrument



AS VERSATILE AS A SWISS ARMY KNIFE

INPUT VARIABLES, MEASURING RANGES

TYPE OF MEASUREMENT	MEASURING RANGE	MINIMUM SPAN
DC voltage	- 1000...1000 mV	2 mV
DC voltage	- 600...600 V	1 V
DC current	50...50 mA	0,2 mA
Resistance	- 0...5000 Ω	8 Ω
RTD Pt100	- 200...850 °C	20 K
RTD Ni100	- 60...250 °C	15 K
TC Type B	0...1820 °C	635 K
TC Type E	- 270...1000 °C	34 K
TC Type J	- 210...1200 °C	39 K
TC Type K	- 270...1372 °C	50 K
TC Type L	- 200...900 °C	38 K
TC Type N	- 270...1300 °C	74 K
TC Type R	- 50...1768 °C	259 K
TC Type S	- 50...1768 °C	265 K
TC Type T	- 270...400 °C	50 K
TC Type U	- 200...600 °C	49 K
TC Type W5Re-W26Re	0...2315 °C	135 K
TC Type W3Re-W25Re	0...2315 °C	161 K

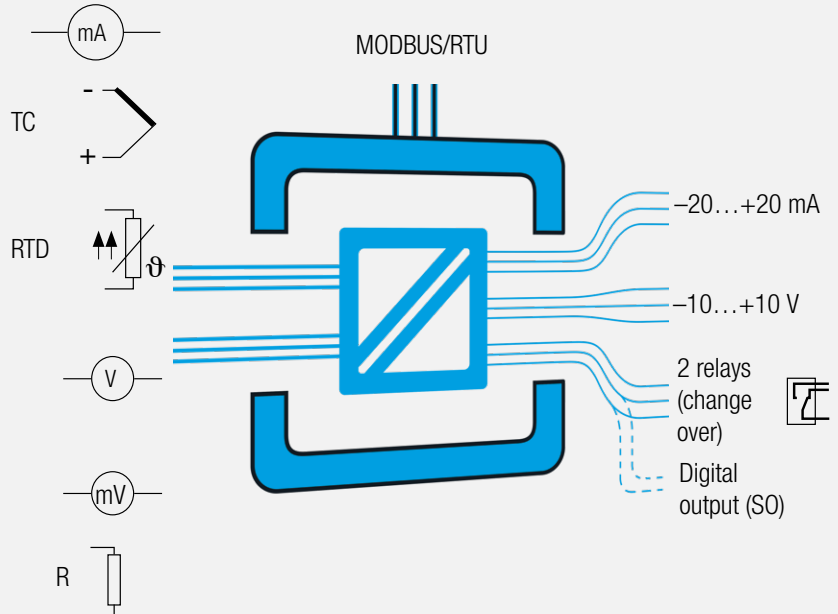

CUSTOMISED ADAPTATIONS

SINEAX V604s may be quickly and easily adapted to the measuring task using CB-Manager software. Direct currents, direct voltages, resistances, potentiometers, thermocouples and resistance thermometers can be measured. Since the specific data is stored for all listed temperature sensors, optimum adaptation to a linear output signals is achieved.

If an individual adaptation of the input signal is required, SINEAX V604s makes a basic linearisation per channel available in which up to 24 basic values can be comfortably allocated to the X and Y coordinates. Input is conveniently effected via a basic value table.

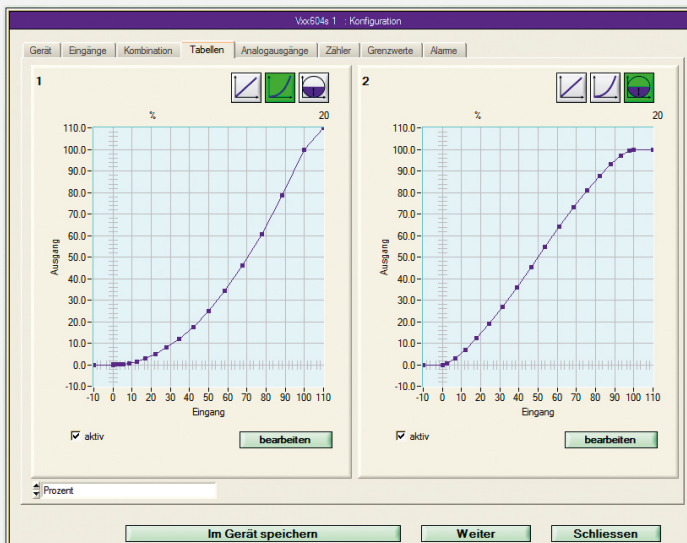

	Eingang	Ausgang
1	-10.00	0.00
2	0.00	0.00
3	0.35	0.00
4	1.38	0.02
5	3.11	0.10
6	5.54	0.31
7	8.65	0.75
8	12.46	1.55
9	16.96	2.87
10	22.15	4.90
11	28.03	7.86
12	34.60	11.97
13	41.87	17.53
14	49.83	24.83
15	58.48	34.20
16	67.82	46.00
17	77.85	60.61
18	88.58	78.47
19	100.00	100.00
20	110.00	110.00

At the bottom of the table window, there is a field for 'Anzahl Datensätze' (Number of data sets) set to 20, and a 'schliessen' (Close) button.



HIGH-LEVEL SAFETY

PERSONAL SAFETY

SINEAX V604s offers protection for people and plants through consistent galvanic isolation of the input, output and power supply circuits. The instrument provides reinforced insulation according to overvoltage category III (Operating voltage 300 V) resp. according to overvoltage category II (Operating voltage 600 V) / test voltage 3.7 kV.

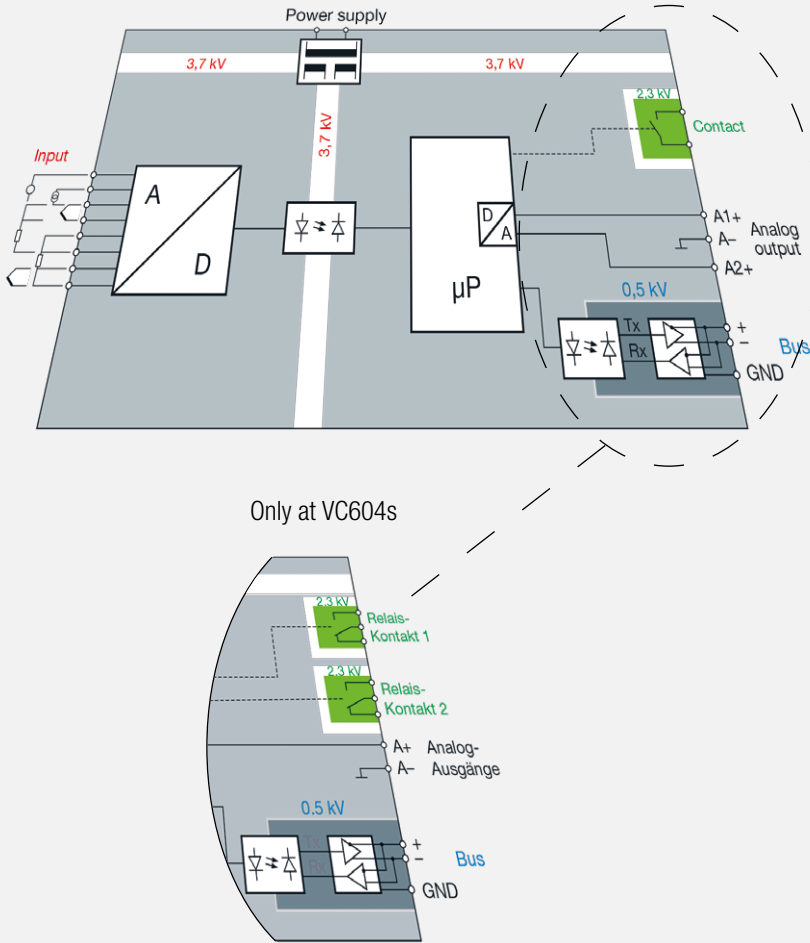

Electromagnetic compatibility	EN 61000-6-2/61000-6-4
Ingress protection (according to IEC EN 60529)	Housing IP 40 Terminals IP 20
Electric design	According to IEC or EN 61010
Degree of pollution	2
Between power supply and all circuits	Reinforced insulation overvoltage category III operating voltage 300 V test voltage 3.7 kV AC rms
Between the measuring input (1+2) and all circuits	Reinforced insulation overvoltage category III operating voltage 300 V overvoltage category II operating voltage 600 V test voltage 3.7 kV AC rms
Between output and relay contact	Reinforce insulation overvoltage category II Operating voltage 300 V Test voltage 2.3 kV AC rms
Between output (1+2) and Modbus connection	Function insulation Operating voltage <50 V Test voltage 0,5 kV AC rms
Environmental testing	EN 60068-2-1/-2/-78/-6/-27

PROCESS SAFETY

SENSOR DRIFT

Sensor drift monitoring concerns the difference of 2 input sensors. If a previously defined deviation is exceeded, an alarm can be issued. Even if the sensors to be monitored have different response times, SINEAX V604s can perform drift monitoring for a certain period of time thus compensating the different response times.

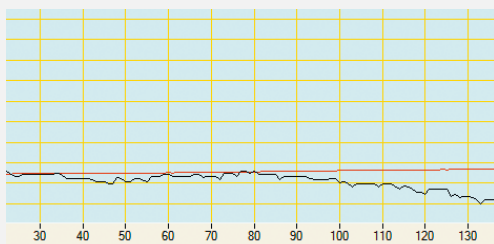

SENSOR BREAKAGE/SHORT CIRCUIT

If a temperature sensor or a resistance sensor is connected to SINEAX V604s, the instrument can perform, apart from the actual measurement, a simultaneous check for a sensor break or short circuit. Users can define the behaviour of the instrument in case of a failure which may be indicated via the analogue output, the relay and/or the alarm function.





PROCESS SAFETY

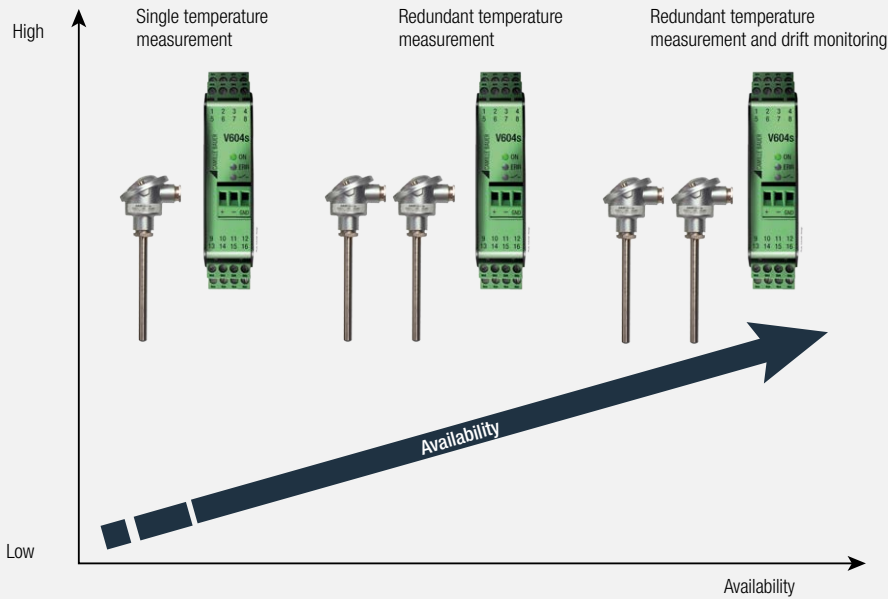

SENSOR REDUNDANCY

If safe and comprehensive temperature measurement is required, SINEAX V604s realises redundant measurement. The instrument measures a temperature using two independent sensors. If a failure occurs in one sensor (short circuit or breakage), V604s switches to the correctly working sensor without any interruption. At the same time, the failure is indicated so that the defective sensor can be replaced. Measurement continues during the sensor change and subsequently uses both sensors again.

ENHANCED APPLICATION POSSIBILITIES OF THE SINEAX V604S

DC ENERGY METER

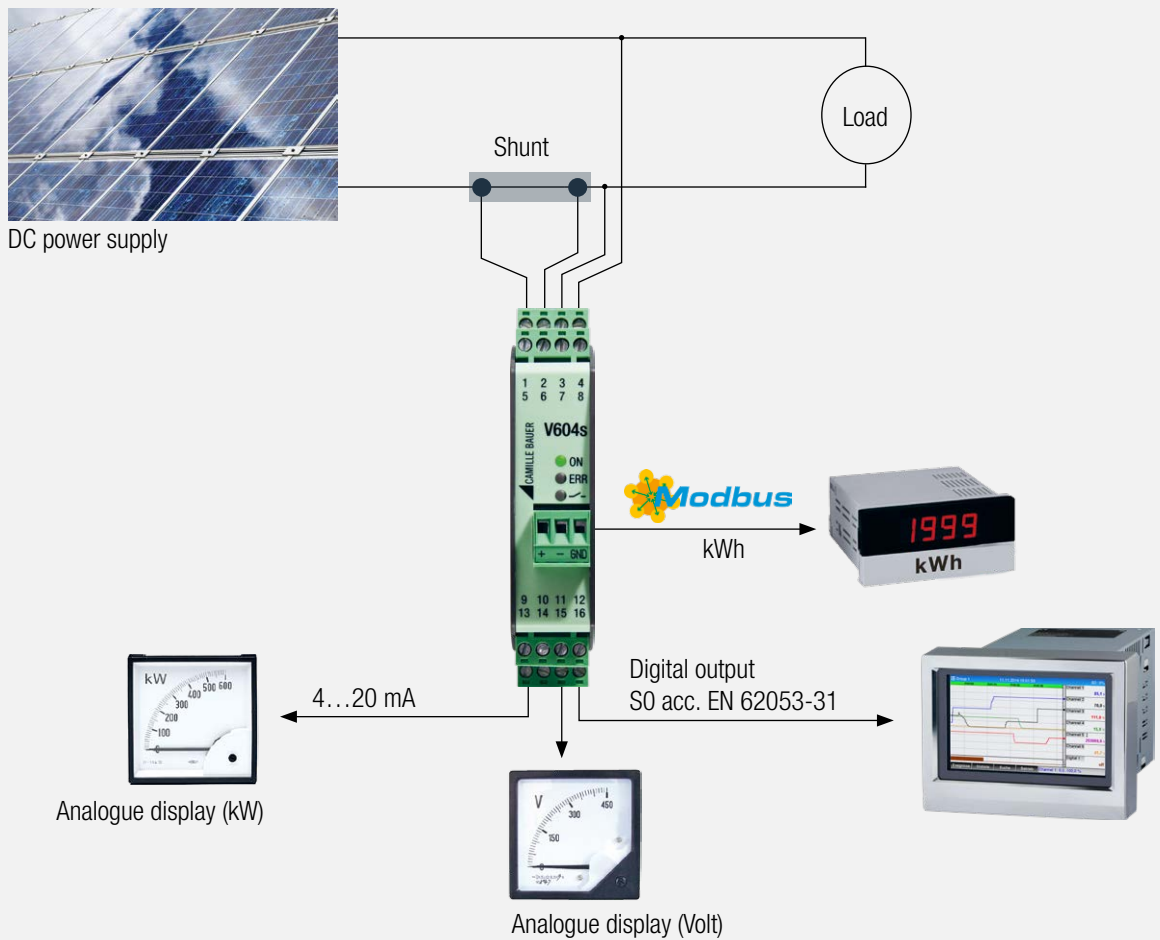



LOAD MONITORING/ENERGY STORAGE

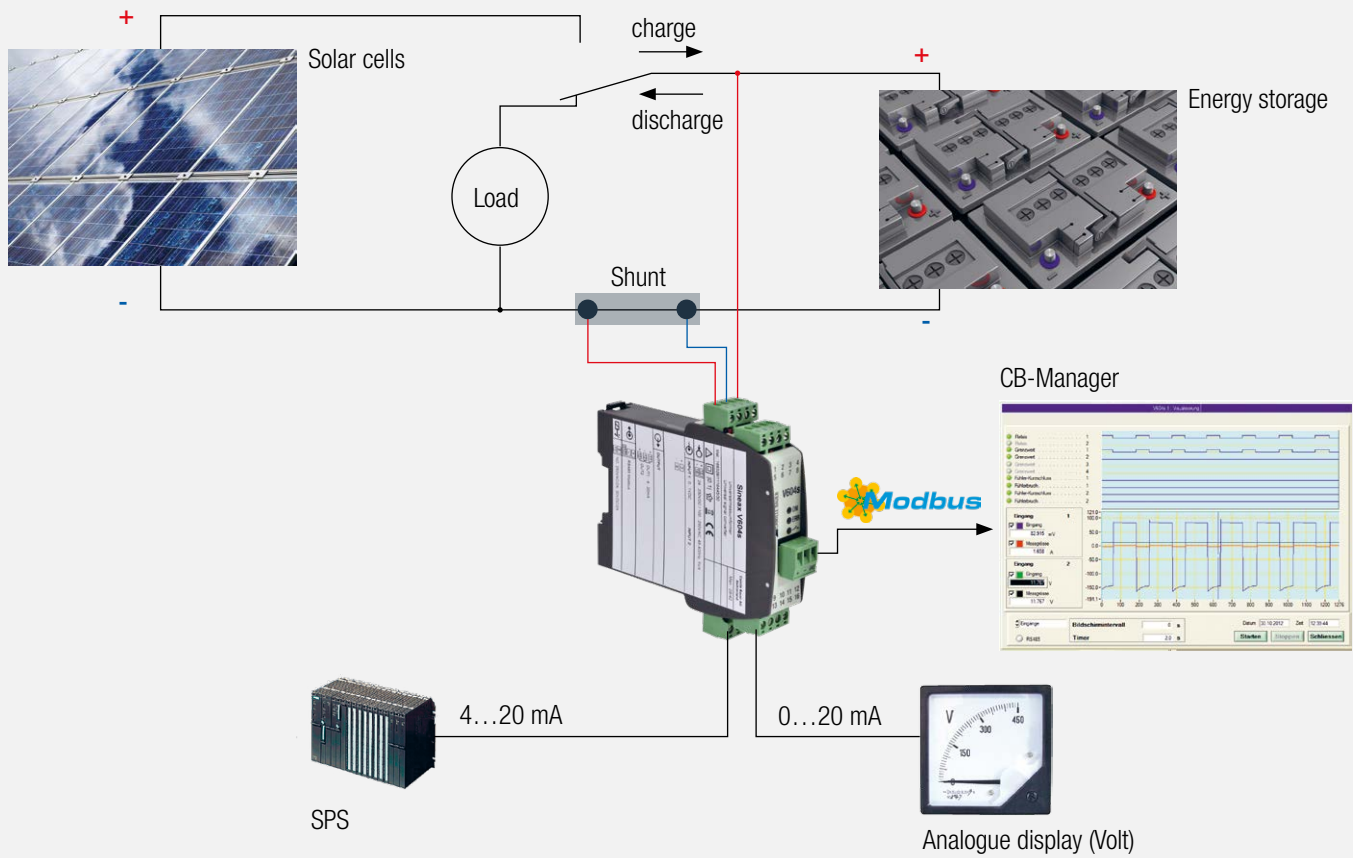

POWER MEASUREMENT

SINEAX V604s measures direct voltages up to 600 VDC and can use them in the calculation of further variables. For example, the voltage and the current may be acquired and used directly to calculate the power.

Since SINEAX V604s has several outputs, other values may be transmitted apart from power. Simultaneous monitoring of limit values does not present any problem either.

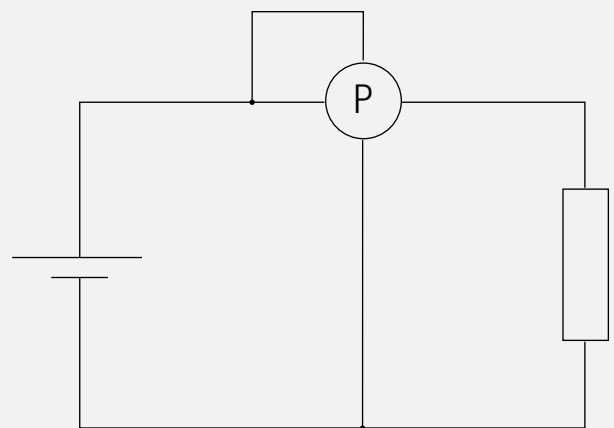
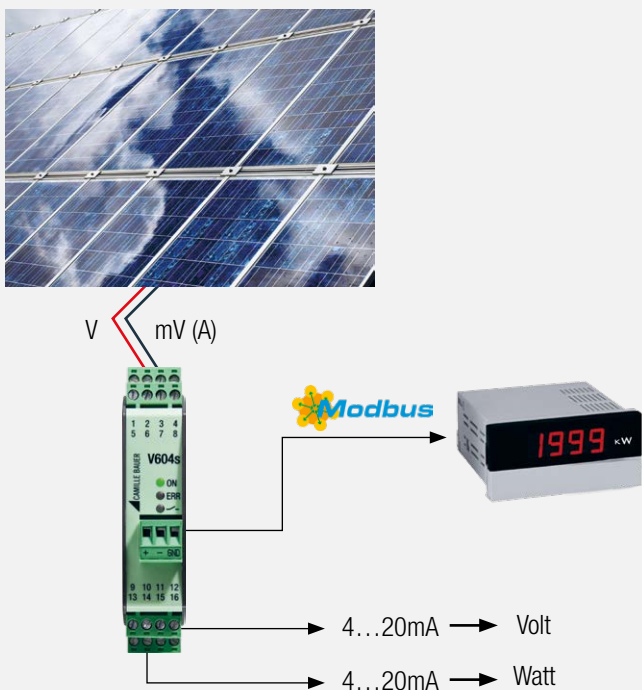



REDUNDANT TEMPERATURE MEASUREMENT

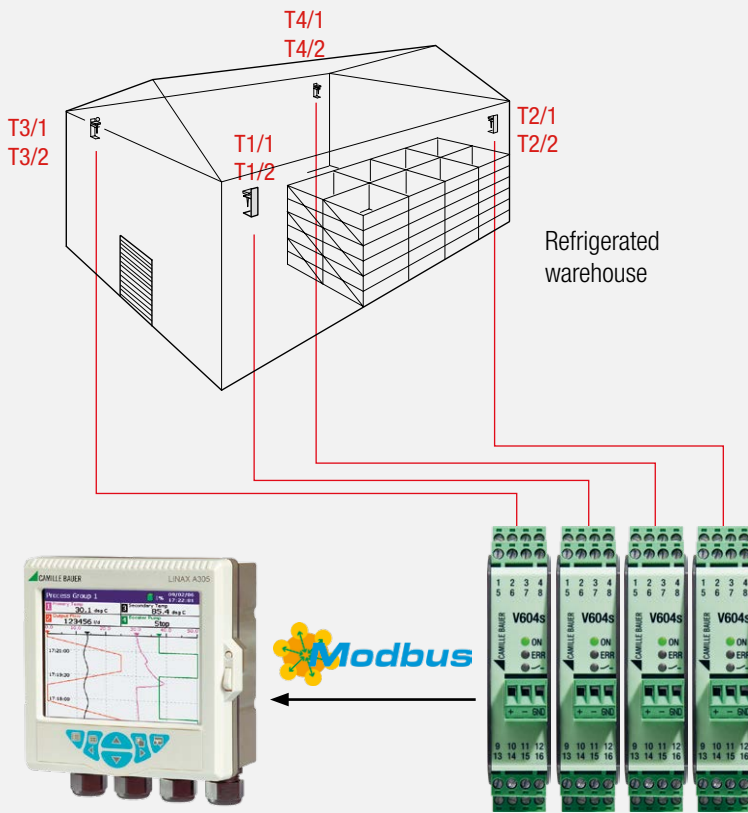

The redundant measurement of critical temperatures constitutes a typical area of applications for SINEAX V604s.

In refrigerated storage, for example, the documentation of uninterrupted cooling is often demanded. If the temperature deviates from the target value at the measuring points for a defined period of time or if records are not available for this period of time, the stored goods can mostly not be used any more for reasons of safety.

In this case, SINEAX V604s offers a safe solution because it measures with 2 independent temperature sensors at each measuring point. If the signal converter is parameterised to redundancy and one of the temperature sensors fails, the device switches to the still working sensor without any interruption and issues an alarm.

At the same time, SINEAX V604s can also monitor slow drifting of a temperature sensor by continually comparing the measured values of the two sensors.

Measured values may be communicated for recording either via the analogue outputs or via the MODBUS interface integrated as a standard feature.

MONITORING OF DIFFERENCES IN TEMPERATURE

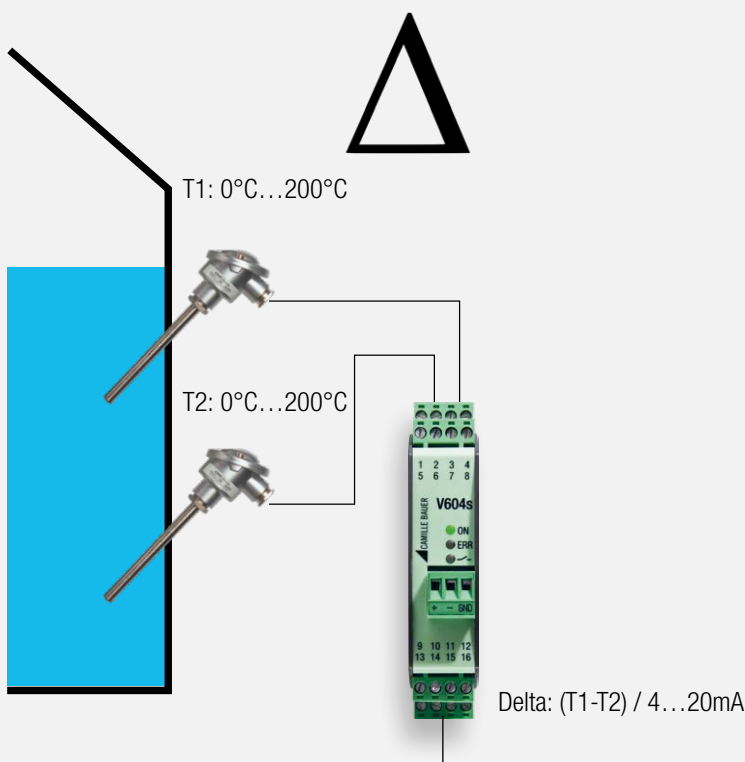

SINEAX V604s is predestined to monitor the difference of 2 input values as it is often the case in temperature monitoring. The 2 input values may be directly subtracted from each other. In addition, SINEAX V604s features a magnifier function which permits that only the measuring range of interest is allocated to the output range.

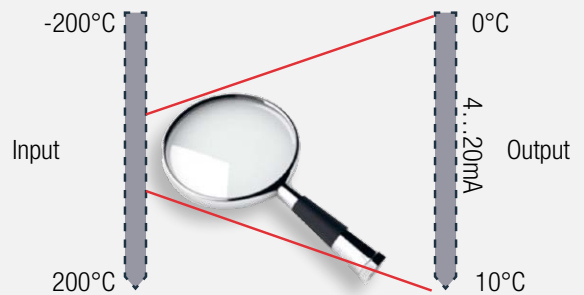

Users can also decide whether they want to see the direction of the change or only the absolute amount of the change irrespective of the sign.

Free allocation of the output: E.g. 0°C...10°C or -5°C...+5°C



LIMIT VALUE/GRADIENT MONITORING

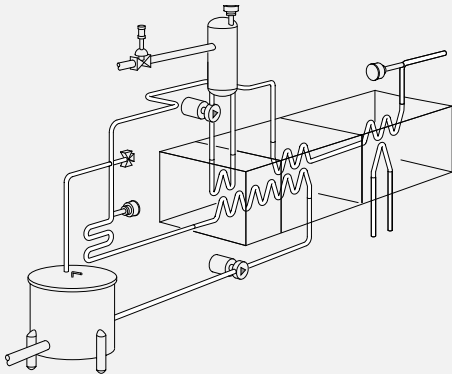

Pasteurising plant

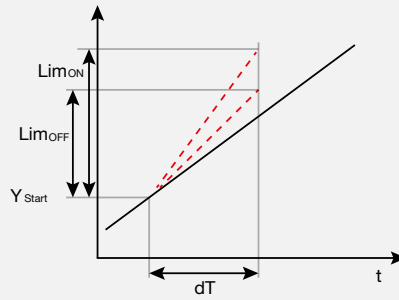

Gradient monitoring

If a sudden change of a process parameter causes problems in a plant, the change of measured values must be constantly monitored. SINEAX V604s monitors the gradients of measured values and can trigger an alarm if defined limiting values are exceeded or intervene in the process in a controlling manner. Gradient monitoring is used, for example, in:

- Level monitoring (tank farms, rain retention basins, pump sumps, etc.)
- Temperature monitoring in pressurised systems
- Extruders
- Injection moulding plants
- Pasteurisation plants
- Process pressure monitoring

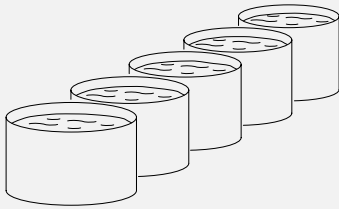

Tank farm



FAST MEASUREMENT WITH VQ604s

SINEAX VQ604s is well-suited to measure rapid signal changes. The instrument is in a position of recognising an input change within from 10ms and issuing the output of this change correspondingly.

Such fast signal changes occur, for example, in the following measurements:

- Arcs in welding facilities, cutting facilities or in glass melting
- Fast pressure changes
- Temperature monitoring in coating processes

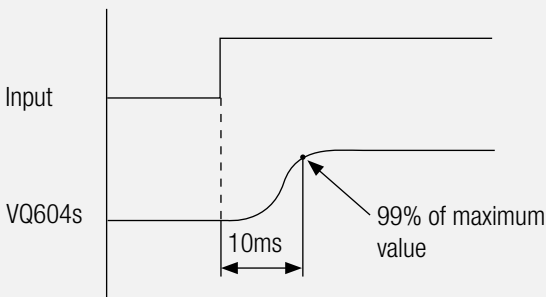



MINI-REMOTE I/O FUNCTIONALITY WITH VB604s

The SINEAX VB604s version activates a bidirectional control via the MODBUS interface which enables the instrument to act as a remote I/O component.

The inputs are "decoupled" from the outputs which means that a change at the inputs does not have a direct effect on the outputs any more. Both outputs as well as the relay may be directly switched via the MODBUS interface.

SINEAX VB604s can thus be used to acquire signals and forward them to a higher-ranking control. At the same time, the control can access field actuators and control them via the outputs of SINEAX VB604s.

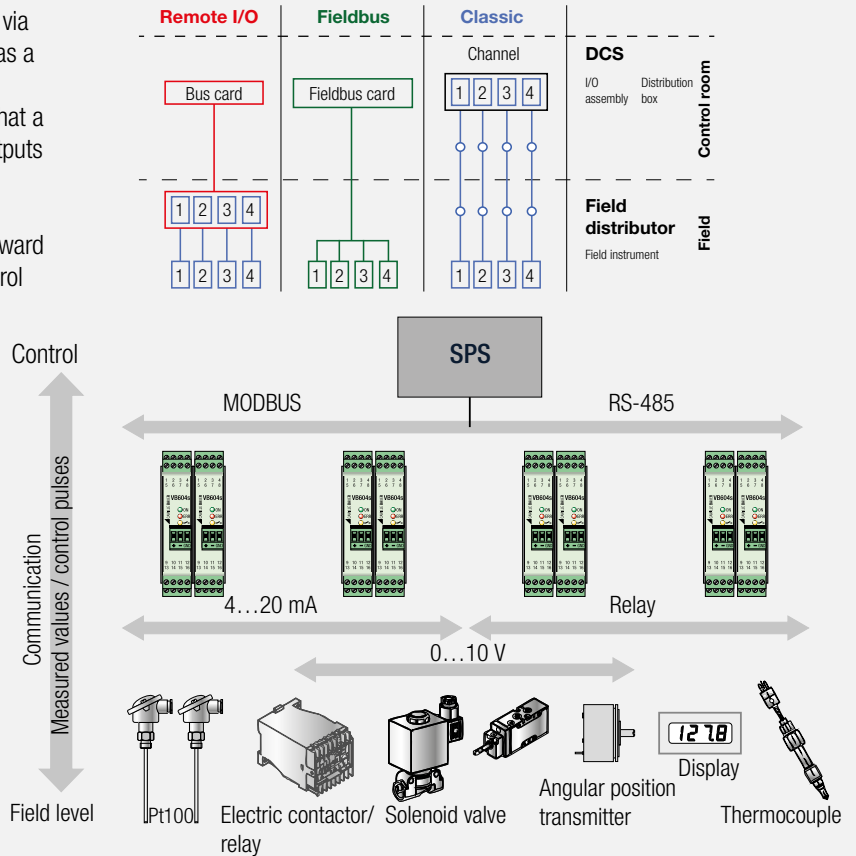

PROCESS INTERFACES

SINEAX V604s communicates in numerous ways with its environment.

COMMUNICATION INTERFACES:

- 2 outputs 4...20 mA for measured values and failure messages according to NAMUR
- MODBUS interface to communicate with higher-ranking systems
- MODBUS interface to parameterise the instrument
- MODBUS interface to visualise and store measured values
- Relay to indicate limit values and alarms
- Digital output for fast impulses (SSR). E.g. as a SO output according to DIN 43864, if the SINEAX V604s is used as a energy meter.

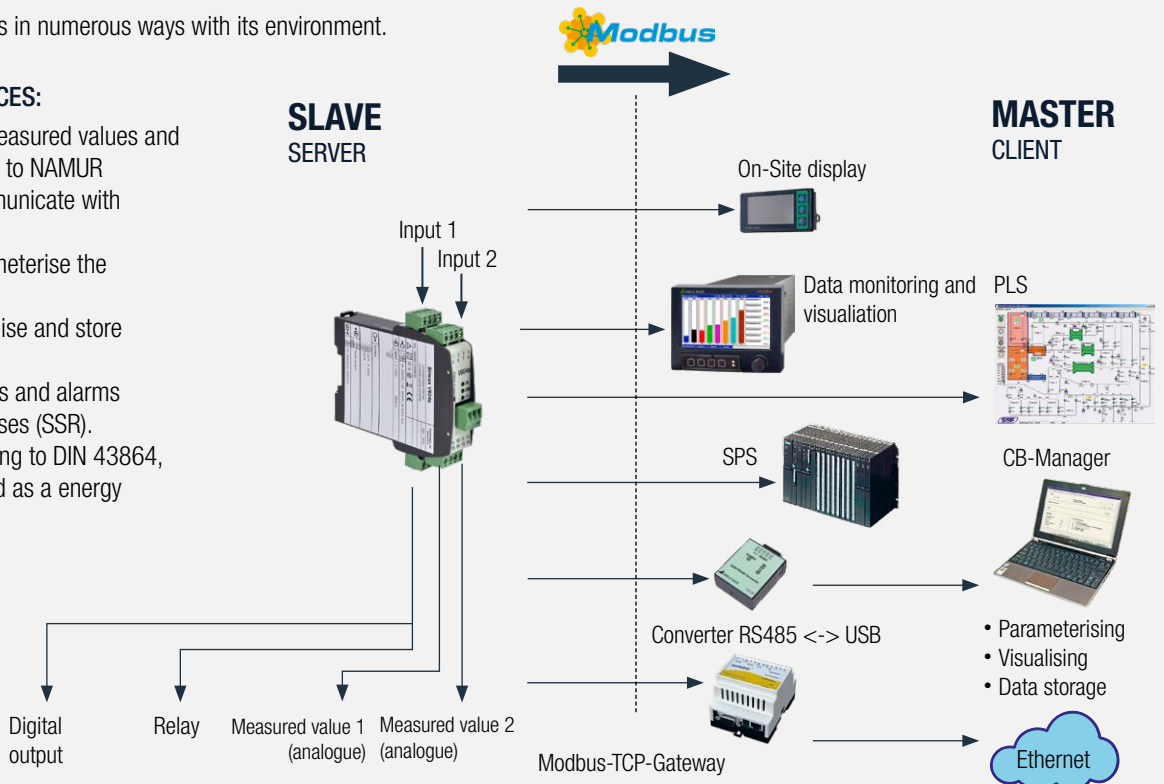



PARAMETERISING, SERVICE AND MEASURED VALUE ACQUISITION

CB-Manager software individually configures all SINEAX V604s variants. The software is included in every instrument delivery or is available for download free of charge from our web page www.camillebauer.com.

CONFIGURATION:

All settings are comfortably arranged via the CB-Manager software. Users are guided step by step through the settings. Depending on the selected settings, only those functions are subsequently released which make sense in the respective context.

The following groups may be configured:

- General instrument and interface settings
- Configuration of inputs
- Mathematical linking of inputs
- Application-specific linearisation
- Configuration of outputs
- Limit value, alarm and relay switching on

Visualising and storing of measured data

Any measured data as well as any status can be visualised online by the CB-Manager software. This concerns the inputs, outputs, the relay status as well as all failure and alarm messages. If the inputs have been mathematically linked, these values may also be displayed.

The data of all visualised values can be stored in form of a file on the computer and loaded again into the CB-Manager at a later time.

The CB-Manager offers the following functions:

- Comfortable complete configuration of V604s
- Storage of configurations
- Visualising of measured values, links as well as alarm and failure statuses
- Storage of recorded measured values
- Extensive service functions

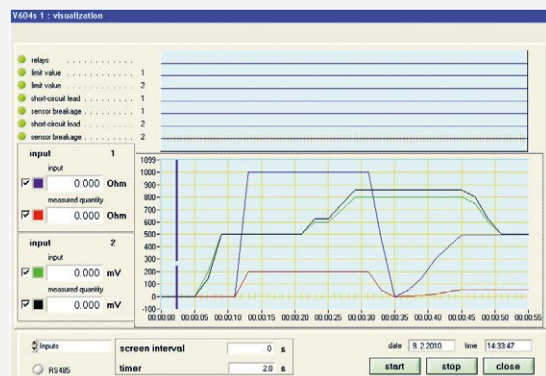
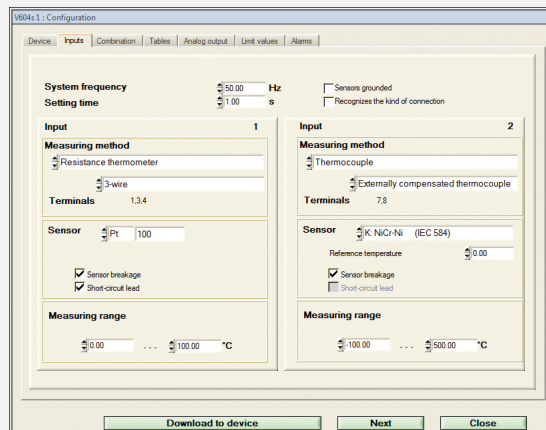

SIMULATION

The CB-Manager simulates the outputs of a connected V604s. This permits the instrument to be comfortably tested during commissioning without any input signal.

ADJUSTMENT

An application might require that the entire measuring chain be adjusted. The output values of SINEAX V604s may be adjusted in this respect.

LEAD CALIBRATION

For resistances or resistance thermometers in 2-wire arrangement, the CB-Manager offers a comfortable option to measure the lead resistance.

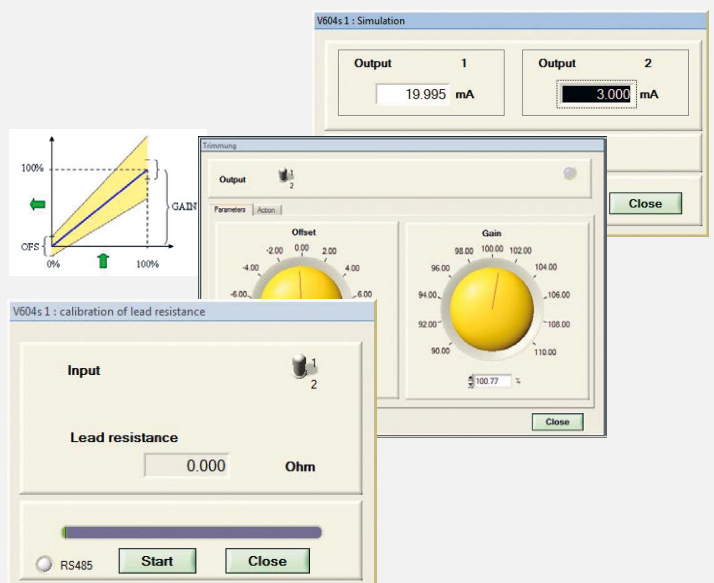

The CB-Manager features a context-related help function which always provides users with the right information concerning a certain item in the configuration program.



APPLICATION EXAMPLES VERSUS INSTRUMENT VERSION

APPLICATION	V604s	VB604s	VC604s	VQ604s
Energy measurement in DC systems	✓			
Monitoring of batteries: Charge (Ah), voltage, etc.	✓			
Power measurement in DC systems with direct DC voltage input of up to +/- 600V	✓			
Power measurement via isolating amplifier with V or mA output	✓	✓	✓	✓
Redundant temperature measurement	✓	✓	✓	✓
Mathematical computation of input variables	✓	✓	✓	✓
Monitoring of deviations between 2 inputs	✓	✓	✓	✓
Allocation of a certain part of a measuring range or a measured variable to an output (zooming)	✓	✓	✓	✓
Monitoring of up to 2 limit values with a normally open relay contact	✓	✓		✓
Monitoring of up to 4 limit values with two change over relay contacts	✓	✓	✓	
Monitoring of changes over time (gradients)	✓	✓	✓	✓
Very fast measurement with a set time (T99) of up to 10ms	✓	✓		✓
Integration on input signals over time	✓	✓		
Control of outputs and relay via MODBUS (remote I/O)	✓	✓		
Signal amplification	✓	✓	✓	✓
Signal adaptation and customised linearisation	✓	✓	✓	✓
Monitoring of line breakage or a short circuit in the connected sensor	✓	✓	✓	✓
INSTRUMENT VERSION				
2 universal inputs (mA, mV, Ω, temperature)	✓	✓	✓	✓
Galvanic isolation of all circuits	✓	✓	✓	✓
AC/DC wide-range power supply unit (24...230V)	✓	✓	✓	✓
Fast measurement up to 10 ms				✓
Number of analogue outputs (mA, V)	2	2	1	2
Relay outputs/digital output	1 normally open (No) or digital output	1 normally open (No)	2 change over	1 normally open (No)
Remote I/O functionality		✓		
Design for 600 V input -600...+600 VDC at one output	✓			
High-quality pluggable screw terminals or spring cage terminal	✓	✓	✓	✓
Output signal (selectable for each output separately)	U or I	U or I	U or I	I
Mathematical linking of inputs	✓	✓	✓	✓
DC-Energy meter	✓	✓		
Sensor drift monitoring	✓	✓	✓	✓
Breakage and short circuit monitoring	✓	✓	✓	✓
Sensor redundancy	✓	✓	✓	✓
MODBUS interface	✓	✓	✓	✓

DIMENSIONS

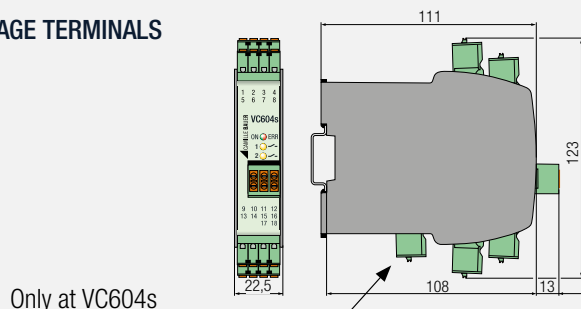

SPRING CAGE TERMINALS

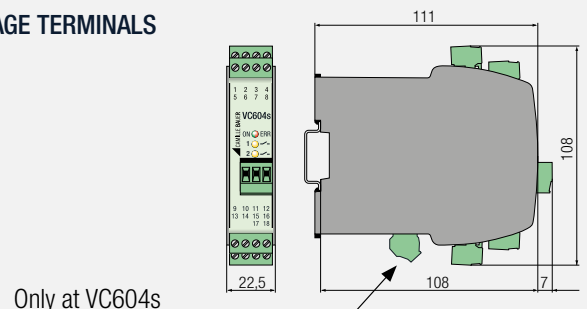

SPRING CAGE TERMINALS



GMC INSTRUMENTS

 **GOSSEN METRAWATT**
 **CAMILLE BAUER**

Camille Bauer Metrawatt AG
Aargauerstrasse 7 ■ 5610 Wohlen ■ Switzerland
TEL +41 56 618 21 11 ■ FAX +41 56 618 21 21

www.camillebauer.com ■ info@cbmag.com

