

Heavy Current Engineering

Camille Bauer

**Heavy current
engineering**

**Angular position
engineering**

**Process control
engineering**

 **CAMILLE BAUER**
Rely on us.

Camille Bauer

Heavy Current Engineering at a glance

Only the best have always been working for us, i.e. our customers and the market with all of its changing and new challenges. This implies a permanent learning aptitude which is consistently implemented in our products - particularly in customised solutions. And this world-wide, always considering local requirements, conditions and regulations. We launch new products as announced. We adhere strictly to confirmed delivery dates. And: Our responsibility in relation to customers does not end upon the conclusion of a sale. Systematic and innovative thinking determines our actions. The concept of all product groups is comprehensive and integrative. In this respect, high priority is given to the interaction of hardware and software.

Our program may be subdivided as follows:

- **Heavy current engineering**
- **Angular position engineering**
- **Process control engineering**

Camille Bauer offers two options for orders: The versatile products of Camille Bauer have different product features. You can obtain products via Order Code or as stock versions.

The Order Code is stated on the data sheets on our homepage:

www.camillebauer.com.

For standard applications, use the 6-digit Article Number stated in this catalogue. These products are on stock and can be supplied within 3 days.

It is a matter of course that our competent sales partners in your country will support you in ordering (please see the inside of the rear cover or visit our homepage).

Our in-house area sales manager will support you in countries which are not listed.

Heavy current engineering

Angular position engineering

Process control engineering

Unifunctional transducers

Multifunctional transducers

Displaying power meters

Energy management

Software, accessories, basics

Indices

 **CAMILLE BAUER**
Rely on us.

Rely on us:
We provide a
3-year warranty for all
Camille Bauer products.

- ▲ Current transducers
- ▲ Voltage transducers

- ▲ High-voltage isolation amplifiers for DC variables

- ▲ Power transducers
- ▲ Frequency and phase angle

3

- ▲ Introduction
- ▲ Overview

- ▲ Multi-transducer M56x
- ▲ Multi-transducer line DME4
- ▲ Universal measuring unit CAM

- ▲ Accessories for multi-transducer line DME4

17

- ▲ Overview

- ▲ Displaying power meters, extendable by modules
- ▲ Displaying power meters, „All in one“

- ▲ Accessories for A210, A220, A230s, A230

29

- ▲ Energy meters
- ▲ Energy Control System (ECS)

- ▲ Summators
- ▲ Additional components for summators
- ▲ Load optimisation

- ▲ Power quality

41

- ▲ Software for heavy current transducers and power meters
- ▲ Software for energy management

- ▲ Accessories for heavy current transducers and power meters

- ▲ Electromagnetic compatibility
- ▲ Environmental testing

59

- ▲ Products of angular position engineering
- ▲ Products of process control engineering

- ▲ Index

- ▲ Our sales partners

70



Content Unifunctional Transducers

Current transducers

Common features 4
I542 5
I538 5
I552 6

Voltage transducers

Common features 7
U543 8
U539 8
U553 9
U554 9
U700, AC voltage difference 10

High-voltage isolation amplifiers for DC variables

TV829 10

Power transducers

Common features 11
P530/Q531, Active or reactive power 11
P200, Active or reactive power 12
P600, Mixed current power 12

Frequency and phase angle

F534, Frequency 13
F535, Frequency difference 14
G536, Phase angle or power factor 15
G537, Phase angle difference 16

Camille Bauer

Current Transducers

4

Transducers for alternating current: Common features

For the conversion of a sinusoidal alternating current into a proportional DC signal.

Customer benefit

- Determination of the variable load of lines and equipment
- Identification of the utilisation ratio by a comparison with the nominal current
- Output signal useable for indication, registration, monitoring and control
- Safety by galvanic isolation and shock-proof terminals (IP20)

Application

The transducers for alternating current of the P-line are typically connected via current transformers, but can also be used for direct measurement. The measurement is effected within the instrument via current transformers which ensure galvanic isolation. The instruments are designed for sinusoidal alternating current signals. Possibly existing direct current portions are not concurrently measured. They provide an output signal in form of a direct current signal which is proportional to the measured current.

The instruments can be easily snapped onto a top-hat rail (35 x 15 mm or 35 x 7.5 mm).

Overview of instruments

O = optional, S = standard

<i>Special features</i>		<i>I542</i>	<i>I538</i>	<i>I552</i>
Input	Measurement of distorted alternating currents			•
	RMS value measurement (standard)			•
	2 measuring ranges (standard)	•		•
	Adjustable maximum value of the measuring range	O	O	S
	Without power supply (standard)	•		
	Nominal frequency 400 Hz (option)			•
Output	Setting time 300 ms	•	•	•
	Setting time 50 ms (option)			•
	Adjustable output signal (option)	•		•
	Live-zero output signal (option)		•	•
Power supply	2-wire technology with 4 ... 20 mA output (option)		•	

For current measurement with sign programmable transducers of the DME4 or M56x lines may be used.

Live-zero output signal

In case of input signal zero the pertaining output signal is non-zero, by definition, e.g. 4 mA with a 4...20 mA output signal. This permits monitoring the instrument operation in a very easy manner since an output value of 0 mA clearly indicates an error. This might be the failure of the power supply or an absent input signal caused by an interruption of a signal line.

2-wire technology

Transducers in 2-wire technology do not require a separate power supply connection. They are supplied via the output circuit. Instruments designed in this way must operate with less than 4 mA supply current but do not need separate electronics for the power supply.

Short-circuiting of current transformers

Conventional current transformers have a ferrite core. If the secondary winding of the transformer is open, it might carry high voltages, which will drive the current transformer to saturation. This might lead to flashovers and heat losses by eddy-currents and magnetic hysteresis losses which could cause a permanent loss in transformer accuracy. In extreme cases it is even destroyed. Therefore, the current input of the current transducer (and all other transducers with current inputs) should always be connected via short-circuiting terminals.

SINEAX I542



Transducer for alternating current

To measure sinusoidal alternating currents, without power supply connection.



Customer benefit

- Without power supply connection, low wiring expenditure
- Standard as GL (Germanischer Lloyd), suitable for ships

Technical data

Meas. input: 0...1 A / 5 A, 0...1.2 A / 6 A or customised (0...0.5 A to 0...7.5 A, only one measuring range), nominal frequency 50/60 Hz
 Meas. output: 0...1 mA, 0...5 mA, 0...10 mA, 0...20 mA or 0...10 V or customised (0...1 V to 0...<10 V)
 Accuracy: Class 0.5 at 15...30 °C
 H x W x D: 69.1 x 35 x 112.5 mm

Stock variants

Article No.	Measuring range, switchable	Output signal
129 595	0...1 A / 5 A	0...5 mA
129 602	0...1 A / 5 A	0...10 mA
129 610	0...1 A / 5 A	0...20 mA
136 417	0...1.2 A / 6 A	0...5 mA
136 425	0...1.2 A / 6 A	0...10 mA
136 433	0...1.2 A / 6 A	0...20 mA

To measure currents with high harmonic content or distorted sinusoidal form SINEAX I552 should be used.

SINEAX I538



Transducer for alternating current

To measure sinusoidal alternating currents, with power supply connection.



Customer benefit

- Also available in cost-effective 2-wire technology
- Standard as GL (Germanischer Lloyd), suitable for ships

Technical data

Meas. input: 0...1 A, 0...5 A or customised 0...0.8 A to 0...1.2 A or 0...4 A to 0...6 A, nominal frequency 50/60 Hz
 Meas. output: 0...20 mA, 4...20 mA, 4...20 mA 2-wire technology, 0...10 V or customised
 Accuracy: Class 0.5 at 15...30 °C
 Power supply: 24–60 V AC/DC, 85–230 V AC/DC or 24 V, 110 V, 115 V, 120 V, 230 V, 400 V AC 50/60 Hz or 24 V DC or 24 V DC via output circuit in 2-wire technology
 H x W x D: 69.1 x 35 x 112.5 mm

Stock variants

Article No.	Measuring range	Output signal	Power supply
137 431	0...1 A	4...20 mA	230 V AC, 4-wire connection
137 449	0...5 A	4...20 mA	230 V AC, 4-wire connection
146 979	0...1 A	4...20 mA	24 V DC, 4-wire connection
136 590	0...1 A	4...20 mA	24 V DC, 2-wire technology
146 987	0...5 A	4...20 mA	24 V DC, 4-wire connection
136 607	0...5 A	4...20 mA	24 V DC, 2-wire technology

To measure currents with high harmonic content or distorted sinusoidal form SINEAX I552 should be used.

Camille Bauer Current Transducers

6

Transducer for alternating current

To measure sinusoidal or distorted alternating currents, with power supply connection.



Customer benefit

- RMS value measurement up to crest factor 6
- 2 measuring ranges
- Possibility of adjusting the maximum value of the measuring range on site
- Standard as GL (Germanischer Lloyd), suitable for ships
- Can also be used for 400 Hz systems

Technical data

Meas. input: 0...1 A / 5 A, 0...1.2 A / 6 A or
customised (0...0.1 / 0.5 A to 0...<1.2 / 6 A)
Nominal frequency 50/60 Hz or 400 Hz

Meas. output: 0...20 mA, 4...20 mA, 0...10 V or customised
Setting time 50 ms or 300 ms

Accuracy: Class 0.5 at 15...30 °C

Power supply: 24–60 V AC/DC, 85–230 V AC/DC or
24 V AC / 24–60 V DC, connection on the low-voltage side

H x W x D: 69.1 x 70 x 112.5 mm

Stock variants

Article No.	Measuring range, switchable	Output signal	Power supply	Setting time
133 760	0...1 / 5 A, 50/60 Hz	4...20 mA	85–230 V, DC or 40–400 Hz	300 ms

SINEAX I552



Transducers for alternating voltage: Common features

For the conversion of a sinusoidal alternating voltage into a proportional DC signal.

Customer benefit

- Determination of the present voltage level
- Determination of the load of the equipment by a comparison with the rated voltage
- Output signal useable for indication, registration, monitoring and control
- Safety by galvanic isolation and shock-proof terminals (IP20)

Application

The transducers for alternating voltage of the P-line may be connected via voltage transformers, but can also be used for direct measurement. They have been designed for the measurement of sinusoidal alternating voltage signals. Possibly existing direct voltage portions are not concurrently measured. They provide an output signal in form of a direct current signal which is proportional to the measured voltage level.

Instruments with live-zero signal can be used for improved failure recognition. If only certain areas of the whole measuring range are of interest, U554 with main value magnification or step point.

The instruments can be easily snapped onto a top-hat rail (35 x 15 mm or 35 x 7.5 mm).

Overview of instruments

<i>Special features</i>		<i>U543</i>	<i>U539</i>	<i>U553</i>	<i>U554</i>
Input	Measurement of distorted alternating voltages			•	•
	RMS value measurement (standard)			•	•
	Nominal frequency 400 Hz (option)			•	•
	Adjustable maximum value of the measuring range (option)	•	•	•	
Output	Live-zero output signal (option)		•	•	•
	Setting time 300 ms	•	•	•	•
	Setting time 50 ms (option)			•	•
	Different characteristics (primary value scale, step)				•
Power supply	Without power supply (standard)	•			
	2-wire technology with 4 ...20 mA output (option)		•		

Camille Bauer Voltage Transducers

8

Transducer for alternating voltage

To measure sinusoidal alternating voltages, without power supply connection.



Customer benefit

- Cost-effective measurement of voltages with low harmonic content
- Without power supply connection, low wiring expenditure

Technical data

Meas. input: Different ranges from 0...100/√3 to 0...500 V or customized
0...20 V to 0...600 V, maximum 300 V nominal value of the system against earth
Nominal frequency 50/60 Hz
Maximum value of the measuring range is fixed or can be set via potentiometer
(approx. ±10%)

Meas. output: 0...1 mA, 0...5 mA, 0...10 mA, 0...20 mA or
0...10 V or customised (0...1 V to 0...<10 V)

Accuracy: Class 0.5 at 15...30 °C

H x W x D: 69.1 x 35 x 112.5 mm

Stock variants

Article No.	Description	Output signal
129 785	0...100 V, 50/60 Hz	0...20 mA
137 142	0...120 V, 50/60 Hz	
129 842	0...250 V, 50/60 Hz	
136 459	0...500 V, 50/60 Hz	

To measure voltages with high harmonic content or distorted sinusoidal form SINEAX U553 or U554 should be used.

Transducer for alternating voltage

To measure sinusoidal alternating voltages, with power supply connection.



Customer benefit

- Cost-effective measurement of voltages with low harmonic content
- Possibility of adjusting the maximum value of the measuring range on site

Technical data

Meas. input: 0...100 V, 0...250 V, 0...500 V or customised 0...50 V to 0...600 V
Nominal frequency 50/60 Hz

Meas. output: 0...20 mA, 4...20 mA, 4...20 mA 2-wire technology, 0...10 V or customised

Accuracy: Class 0.5 at 15...30 °C, Class 1 if $U_n > 500$ V

Power supply: 24–60 V AC/DC, 85–230 V AC/DC or
24 V, 110 V, 115 V, 120 V, 230 V, 400 V AC 50/60 Hz or
24 V DC or 24 V DC via output circuit in 2-wire technology

H x W x D: 69.1 x 35 x 112.5 mm

Stock variants

Article No.	Measuring range	Output signal	Power supply
146 995	0...100 V, 50/60 Hz	4...20 mA	230 V AC, 4-wire connection
147 000	0...250 V, 50/60 Hz	4...20 mA	
147 018	0...500 V, 50/60 Hz	4...20 mA	
136 699	0...100 V, 50/60 Hz	4...20 mA	24 V DC, 2-wire connection
126 971	0...500 V, 50/60 Hz	4...20 mA	

To measure voltages with high harmonic content or distorted sinusoidal form SINEAX U553 or U554 should be used.

SINEAX U543



SINEAX U539



SINEAX U553



Transducer for alternating voltage

To measure sinusoidal or distorted alternating voltages, with power supply connection.



Customer benefit

- RMS value measurement up to crest factor 6
- Possibility of adjusting the maximum value of the measuring range on site
- Standard as GL (Germanischer Lloyd), suitable for ships
- Can also be used for 400 Hz systems

Technical data

Meas. input: Different ranges from 0...100/ $\sqrt{3}$ to 0...500 V or customized
0...20 V to 0...690 V, maximum 400 V nominal value of the system against earth
Nominal frequency 50/60 Hz or 400 Hz
Maximum value of the measuring range can be set via potentiometer (approx. $\pm 15\%$)

Meas. output: 0...20 mA, 4...20 mA, 0...10 V or customized
0...1 to 0...20 mA or 0.2...1 to 4...20 mA or
0...1 to 0...10 mA or 0.2...1 to 2...10 V
Setting time 50 ms or 300 ms

Accuracy: Class 0.5 at 15...30 °C

Power supply: 24–60 V AC/DC or 85–230 V AC/DC (also from measurement input) or
24 V AC / 24–60 V DC, connection on the low-voltage side

H x W x D: 69.1 x 70 x 112.5 mm

SINEAX U554



Transducer for alternating voltage

To measure sinusoidal or distorted alternating voltages, with power supply connection.

Customer benefit

- RMS value measurement up to crest factor 6
- The measuring range which is of interest can be highlighted

Technical data

Meas. input: Minimum value 0 V, maximum value of the measuring range $E3 = 20...690$ V,
Step point $0.1 \cdot E3...0.9 \cdot E3$
Nominal frequency 50/60 Hz or 400 Hz

Meas. output: Maximum value $A3 = 1$ mA, 5 mA, 10 mA, 20 mA, 10 V or customised 1...20 mA
or 1...10 V

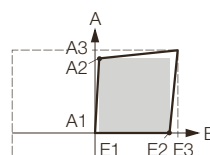

$$E1 = 0$$

$$0.1 \cdot E3 \leq E2 \leq 0.9 \cdot E3$$

$$A1 = 0$$

$$A1 \leq A2 \leq 0.9 \cdot A3$$

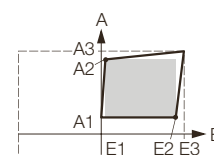

$$E1 = 0$$

$$0.1 \cdot E3 \leq E2 \leq 0.9 \cdot E3$$

$$A1 = 0.2 \cdot A3$$

$$A1 \leq A2 \leq 0.9 \cdot A3$$

Accuracy: Class 0.5 at 15...30 °C

Power supply: 24–60 V AC/DC or 85–230 V AC/DC (also from measurement input)
24 V, 110 V, 115 V, 120 V, 230 V, 400 V AC 50/60 Hz or
24 V AC / 24–60 V DC, connection on the low-voltage side

H x W x D: 69.1 x 70 x 112.5 mm

Camille Bauer Voltage Transducers

10

Transducer for alternating voltage difference

Measures the alternating voltage difference of 2 galvanically isolated systems.

Customer benefit

- Auxiliary variable to synchronise two systems
- The measuring range which is of interest can be highlighted

Technical data

Meas. input: Voltages of $U_n = 10 \dots 500$ V, measuring range $\pm 20\% U_n$
Nominal frequency 50 or 60 Hz

Meas. output: $0 \dots 1$ mA to $0 \dots 20$ mA or $1 \dots 5$ mA to $4 \dots 20$ mA
unipolar, bipolar, live-zero

Accuracy: Class 0.5

Power supply: AC: 115 V or 230 V $\pm 20\%$, 42–70 Hz
DC: 24–110 V, $-15\% \dots +33\%$

H x W x D: 125 x 70 x 126 mm or
plug-in card in European format, face plate width 7 TE (EURAX)

For 19" assembly rack for EURAX plug-in cards see Page 28

SINEAX U700



EURAX U700



High-voltage isolation amplifier for up to 3.6 kV DC

for shunt and voltage measurement on high potential.

Customer benefit

- Safe galvanic isolation according to DIN EN 61 010-1 and DIN EN 50 124 (Cat. III)
- High test voltage: 10 kV
- Calibrated range shift
- High common-mode rejection ratio: 150 dB

Technical data

Input (switch-over): ± 60 mV, ± 90 mV, ± 150 mV, ± 300 mV, ± 500 mV, ± 10 V¹
 ± 400 V, ± 600 V, ± 800 V, ± 1000 V, ± 1200 V
 ± 1400 V, ± 1600 V, ± 1800 V, ± 2000 V, ± 2200 V, ± 3600 V²

Output (switch-over):: $4 \dots 20$ mA, ± 20 mA, ± 10 V

Power supply: 24–253 AC/DC

H x W x D: 90 x 22.5 x 118 mm (Article No. 158 312)
90 x 67.5 x 118 mm (Article Nos. 158 320 to 164 004)

Stock variants

Article No.	Description
158 312	Shunt measurement: ± 60 mV, ± 90 mV, ± 150 mV, ± 300 mV, ± 500 mV, ± 10 V ¹
158 320	Voltage measurement: ± 400 V, ± 600 V, ± 800 V, ± 1000 V, ± 1200 V
158 338	Voltage measurement: ± 1400 V, ± 1600 V, ± 1800 V, ± 2000 V, ± 2200 V, ± 3600 V
159 807	Voltage measurement: $0 \dots 1500$ V
163 981	Voltage measurement: ± 3600 V, Measuring output: ± 10 V
163 999	Voltage measurement: ± 3600 V, Measuring output: ± 20 mA
164 004	Voltage measurement: ± 3600 V, Measuring output: $4 \dots 20$ mA

¹ Only output ± 10 V

SINEAX TV829



Power transducers: Common features

To convert active or reactive power into a proportional DC signal.

Customer benefit

- Determination of the chronological progression of the power input
- Avoidance of under and overload situations, load control
- Monitoring of rotating machines
- Monitoring for blockages, e.g. in conveyor facilities
- Monitoring of energy distribution
- Output signal useable for indication, registration, monitoring and control
- Safety by galvanic isolation and shock-proof terminals (IP20)

Application

The transducers for active or reactive power may be connected via current and voltage transformers, but can also be used for direct measurement. They provide an output signal in form of a direct current signal which is proportional to the measured power. Depending on the application, versions for measurement in single-phase or three-phase systems with balanced or unbalanced loads are available.

The instruments can be easily snapped onto a top-hat rail (35 x 15 mm or 35 x 7.5 mm).

Stock variants

Special features	P530	Q531	P200	P600
Measured variable active power	•		•	
Measured variable reactive power		•	•	
Measured variable mixed current power				•
Measured variable direct current power				•

SINEAX P530/Q531



For single-phase system



For 3/4-wire three-phase system

Transducer for active or reactive power

To measure the active power/reactive power of a single-phase alternating current or a three-phase current.



Customer benefit

- Monitoring of power consumption in energy distribution systems and process engineering
- Standard as GL (Germanischer Lloyd), suitable for ships

Technical data

- Meas. input: Single-phase alternating current, 3-wire three-phase current with balanced/unbalanced loads or 4-wire three-phase current with balanced (only P530) / unbalanced loads
 Nominal voltage U_n 100...115 V, 200...230 V, 380...440 V, 600...690 V or 100...690 V
 Nominal current I_n 1 A, 5 A or customised (1...6 A)
 Maximum value of the measuring range ≥ 0.75 to $1.3 \cdot$ nominal output, unipolar or bipolar
 Nominal frequency 50/60 Hz, sinusoidal
- Meas. range: P530: Maximum value ≤ 0.75 to $1.3 \cdot$ nominal output, unipolar or bipolar
 Q531: Maximum value ≤ 0.5 to $1.0 \cdot$ nominal output, unipolar or bipolar
- Meas. output: Maximum output value 1 mA, 2.5 mA, 5 mA, 10 mA, 20 mA, 10 V or customised 1...20 mA or 1...10 V
 Output signal unipolar, bipolar or live-zero
 Setting time < 300 ms
- Meas. principle: TDM method
- Accuracy: Class 0.5 at 15...30 °C
- Power supply: 24–60 V AC/DC, 85–230 V AC/DC, ≥ 85 –230 V AC from measurement input or 24 V AC / 24–60 V DC, connection on the low-voltage side
- H x W x D: 69.1 x 70 x 112.5 mm (single-phase)
 69.1 x 105 x 112.5 mm (3/4 wire three-phase current)

Transducer for active or reactive power

To measure the power of a single-phase alternating current or a three-phase current.

Customer benefit

- Very fast power measurement, suited to control and protect
- Possibility of adjusting the maximum value of the measuring range on site (via hyper terminal)
- Can also be used for 16 $\frac{2}{3}$ -Hz systems

Technical data

Meas. input: Input voltage 5...300 V AC (phase-neutral)
 Input current 0.5...6 A
 Nominal frequency 16 $\frac{2}{3}$, 50, 60 Hz
 Maximum value of the measuring range 0.3...2.0 x P_n, unipolar or bipolar

System

configurations: Single-phase alternating current
 3/4-wire three-phase current with balanced/unbalanced load
 Meas. output: Maximum output value 0...1 to 0...20 mA or 0...1 to 0...10 V
 Output signal unipolar, bipolar or live-zero
 Setting time: T99 (block mode filter): ½, 1, 2, 4, 8 or up to 64 system cycles
 T63 (exponential mode): 3...200 ms
 T99 (exponential mode): 4.6 x T63

Meas. principle: TDM method

Accuracy: Class 0.5

Power supply: AC: 115 V or 230 V \pm 15%, 45–65 Hz
 DC: 20–135 V

H x W x D: 125 x 70 x 126 mm

Transducer for mixed current power

Acquisition of power components of a mixed current (current with DC and AC portions).

Customer benefit

- RMS value measurement up to crest factor 2
- Possibility of adjusting the maximum value of the measuring range on site
- Can also be used for 400 Hz systems

Technical data

Meas. input: Input voltage between 0...300 mV and 800 V or \pm 150 mV and \pm 800 V
 Input current direct 0...1 mA and 0...50 mA or \pm 1 and \pm 500 mA or
 from shunt 0...300 mV and 0...3 V or \pm 150 mV and \pm 3 V
 Nominal frequency DC / 10...70...400 Hz
 Maximum values of the measuring range 0.75...1.5 · U_n · I_n, bipolar ranges also possible

Meas. output: Maximum output value selectable 1...20 mA or 1...15 V
 Output signal unipolar, bipolar or live-zero
 Setting time 300 ms
 Also available with 2 galvanically isolated outputs

Meas. method: Only direct current power measurement (AC filtered) or mixed current power measurement unfiltered or with an eliminated DC portion or AC measurement, pulse groups

Meas. principle: TDM method

Accuracy: Class 0.5

Power supply: AC: 115 V or 230 V 50/60 Hz or
 DC: U_n 24–110 V

H x W x D: 130 x 70 x 126 mm

SINEAX P200



SINEAX P600



SINEAX F534



Transducer for frequency

For the conversion of the frequency of a system into a proportional DC signal.



13

Customer benefit

- Determination of the progression and stability of the fundamental frequency of an electric system
- Standard as GL (Germanischer Lloyd), suitable for ships (only SINEAX design)
- Output signal useable for indication, registration, monitoring and control
- Safety by galvanic isolation and shock-proof terminals (IP20)

Application

Frequency is an important command variable of electric systems or power distribution systems. Variations of the system frequency particularly occur in system overload or underload situations. They must be immediately recognised in order to take countermeasures in time. Frequency fluctuations impair the performance of connected machines disproportionately. However, this can also be utilised in drive engineering to improve start and speed characteristics e.g. in frequency converters where the frequency is employed as a control variable.

The frequency is measured via a zero-phase voltage or voltage between phases which can be directly connected via a converter. The instrument is also suited to distorted voltages with dominant fundamental waves. A direct current signal proportional to the measured frequency is available at the output.

Technical data

Meas. input:	Input nominal voltage 10...230 V or 230...690 V
Meas. range:	45...50...55 Hz, 47...49...51 Hz, 47.5...50...52.5 Hz, 48...50...52 Hz, 58...60...62 Hz or customised between 10 and 1500 Hz
Meas. output:	Maximum output value 0...20 mA, 4...20 mA, 0...10 V or customised in the 1...20 mA or 1...10 V range Output signal unipolar, symmetrically bipolar or live-zero Setting time selectable 2, 4, 8 or 16 cycles of the input frequency
Accuracy:	Class 0.2 at 15...30 °C
Power supply:	24–60 V AC/DC or 85–230 V AC/DC (also internally from measurement input) 24 V AC / 24–60 V DC, connection on the low-voltage side
H x W x D:	69.1 x 70 x 112.5 mm (SINEAX), assembly on top-hat rail (35 x 15 mm or 35 x 7.5 mm)

Camille Bauer

Frequency and Phase Angle

14

Transducer for frequency difference

Acquisition of the frequency difference of two systems to be synchronised.



Customer benefit

- Determination of the frequency difference as a synchronisation control variable
- Standard as GL (Germanischer Lloyd), suitable for ships
- Output signal useable for indication, registration, monitoring and control
- Safety by galvanic isolation and shock-proof terminals (IP20)

Application

Voltage, phase and frequency balance are the basic preconditions to enable the parallel connection of generators on one bus bar.

The frequency difference is determined by the simultaneous measurement of the voltages of the bus bar and the generator unit to be energised. The instrument is also suited to distorted voltages with dominant fundamental waves. A direct current signal proportional to the measured frequency difference is available at the output.

Technical data

Meas. input: Input nominal voltage 10...230 V or 230...690 V

Meas. range: $f_S = 50$ Hz: $f_G = 49.5...50...50.5$ Hz, $f_G = 47.5...50...52.5$ Hz,
 $f_G = 47.5...50...52.5$ Hz, $f_G = 40...50...60$ Hz, $f_S = 60$ Hz:
 $f_G = 57.5...60...62.5$ Hz or customised between 10 and 1500 Hz
[f_S =frequency bus bar, f_G =frequency generator]

Meas. output: Maximum output value 0...20 mA, 4...20 mA, 0...10 V or customised in the 1...20 mA or 1...10 V

Output signal unipolar, symmetrically bipolar or live-zero

Setting time selectable 2, 4, 8 or 16 cycles of the input frequency

Accuracy: Class 0.2 at 15...30 °C

Power supply: 24–60 V AC/DC or 85–230 V AC/DC (also internally from measurement input)
24 V AC / 24–60 V DC, connection on the low-voltage side

H x W x D: 69.1 x 70 x 112.5 mm (SINEAX),
assembly on top-hat rail (35 x 15 mm or 35 x 7.5 mm)

SINEAX F535



SINEAX G536



Transducer for phase angle or power factor

Acquisition of the phase angle or power factor between the current and voltage of a single-phase system or a symmetrically loaded three-phase system.



15

Customer benefit

- Monitoring of the reactive power requirement in energy distribution systems and process engineering
- Determination of characteristic value for reactive power compensation
- Standard as GL (Germanischer Lloyd), suitable for ships
- Output signal useable for indication, registration, monitoring and control
- Safety by galvanic isolation and shock-proof terminals (IP20)

Application

The instrument serves the acquisition of losses which are caused by non-linear loads or reactive impedances. During a day, these might strongly fluctuate which impedes static reactive power compensation since overcompensation is not permitted.

The transducer for phase angle or power factor can be connected via current and voltage transformer or directly. The instrument is also suited to distorted input variables with dominant fundamental waves. At the output, a direct current signal proportional to the measured phase angle or power factor between current and voltage is available.

Technical data

- Meas. input: Single-phase alternating current system or 3/4-wire three-phase system of the same load
Nominal voltage 100 V, 230 V, 400 V or customised 10...690 V
Nominal current 1 A, 5 A or customised 0.5...6 A
Nominal frequency 50/60 Hz or 10...400 Hz
- Meas. range: Phase angle $-60^{\circ} \dots 0^{\circ} \dots +60^{\circ}$ el or within $-180^{\circ} \dots 0^{\circ} \dots +180^{\circ}$ el or power factor 0.5...cap...0...ind...0.5 or within $-1 \dots \text{ind} \dots 0 \dots \text{cap} \dots 1 \dots \text{ind} \dots 0 \dots \text{cap} \dots -1$
Measuring span $\geq 20^{\circ}$ el, unambiguous indication only up to $-175^{\circ} \dots 0^{\circ} \dots +175^{\circ}$ el
- Meas. output: Maximum output value 0...20 mA, 4...20 mA, 0...10 V or customised in the 1...20 mA or 1...10 V range
Output signal unipolar, symmetrically bipolar or live-zero
Setting time selectable 2, 4, 8 or 16 cycles of the input frequency
- Accuracy: Class 0.5 at 15...30 °C
- Power supply: 24–60 V AC/DC or 85–230 V AC/DC (also internally from measurement input)
24 V AC / 24–60 V DC, connection on the low-voltage side
- H x W x D: 69.1 x 70 x 112.5 mm (SINEAX),
assembly on top-hat rail (35 x 15 mm or 35 x 7.5 mm)

Camille Bauer

Frequency and Phase Angle

16

Transducer for phase angle difference

Acquisition of the phase angle difference of two systems to be synchronised.



Customer benefit

- Determination of the phase angle difference as a synchronisation control variable
- Standard as GL (Germanischer Lloyd), suitable for ships
- Output signal useable for indication, registration, monitoring and control
- Safety by galvanic isolation and shock-proof terminals (IP20)

Application

Voltage, phase and frequency balance are the basic preconditions to enable the parallel connection of generators on one bus bar.

The phase angle difference is determined by the simultaneous measurement of the voltage of the bus bar and the generator unit to be energised. The instrument is also suited to distorted voltages with dominant fundamental waves. A direct current signal proportional to the measured phase angle difference is available at the output.

Technical data

- Meas. input: Input nominal voltage 10...230 V or 230...690 V
Nominal frequency 50 Hz, 60 Hz or customised 10...400 Hz
- Meas. range: $-120^{\circ} \dots 0^{\circ} \dots 120^{\circ}$ el or customised within $-180^{\circ} \dots 0^{\circ} \dots 180^{\circ}$ el,
in which measuring span $\geq 20^{\circ}$ el, unambiguous indication only
up to $-175^{\circ} \dots 0^{\circ} \dots +175^{\circ}$ el
- Meas. output: Maximum output value 0...20 mA, 4...20 mA, 0...10 V or
customised in the 1...20 mA or 1...10 V range
Output signal unipolar, symmetrically bipolar or live-zero
Setting time selectable 2, 4, 8 or 16 cycles of the input frequency
- Accuracy: Class 0.2 at 15...30 °C
- Power supply: 24–60 V AC/DC or 85–230 V AC/DC (also internally from measurement input)
24 V AC / 24–60 V DC, connection on the low-voltage side
- H x W x D: 69.1 x 70 x 112.5 mm (SINEAX),
assembly on top-hat rail (35 x 15 mm or 35 x 7.5 mm)

SINEAX G537



Content Multifunctional Transducers

Introduction	18
Overview	19
Multi-transducer M56x	
M561 / M562 / M563	20
Multi-transducer line DME4	
Overview	21
DME424/442	22
DME401/DME440 Modbus	23
DME406 Profibus DP	24
DME400 LON	24
Universal measuring unit CAM	
CAM	25
EDS-CAM	26
Accessories for transducer line DME4	
A200, display unit for transducer line DME4	28
For 19" assembly rack EURAX BT901	28

Introduction

Introduction

Conventional transducers for heavy current variables are an excellent aid to acquire individual electric variables in energy distribution, automation or process engineering and to process them in accordance with requirements. However, if several variables are to be acquired, microcontroller-based multifunctional instruments constitute the more effective and more cost-effective solution:

Less assembly and wire expenditure

- Less copper
- Less installation time
- Reduced susceptibility to failures

Flexibility

- Several measured variables per instrument
- Lower planning costs due to fewer components
- Adaptable to application by software
- Analysis and monitoring options
- No fixed measuring ranges
- Hardly any hardware variants
- Reduced stocks

Risk

- All of the information is lost in an instrument failure

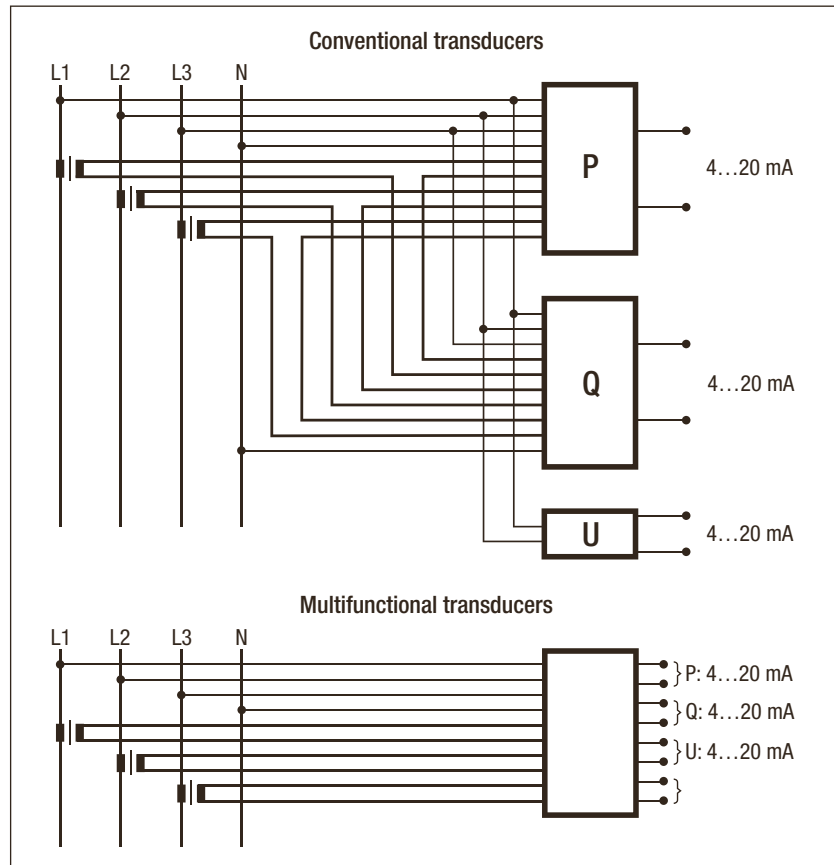

Operating principle of sampling systems

1. Measurement of the fundamental frequency of the system. Simpler instruments presuppose a constant system frequency which can lead to larger errors.
2. Sampling of the input variables of voltage and current of all phases based on the measured fundamental frequency. Quality criteria are the number of sampling operations per system cycle and the reproducible resolution of the measuring system. The correct timing of the sampling process is also very important so that unbalances and phase shifting can be properly analysed.
3. Calculation of the required measured variables, based on the sampling values.
4. Measured values are made available to the process. They may be analogue values for a PLC or an analogue indicator, states of a limit value monitoring system or digital measured values via a bus interface.
5. More extensive analyses. The possibilities are limited by the capacity of the uC system used. Camille Bauer makes available systems with different capacities.

pective PC software which is made available free of charge by us. Service functions support users during commissioning. In this way, e.g. values of analogue or digital outputs can be simulated to test subsequent circuits without the measurement input having to be connected or activated. Instrument variants with a bus connection provide all acquired measured values via the corresponding digital interface. The respective documentation is attached to the instrument or can be downloaded from our homepage <http://www.camillebauer.com>

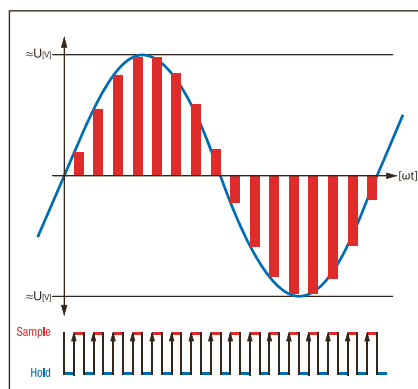

Application



The opposite table helps in the selection of the instrument family. This is an overview, details concerning individual instrument variants are contained in subsequent pages. Multifunctional transducers can be connected via current and voltage transformers or directly. All Camille Bauer lines can be used universally. The application (system configuration) as well as nominal values of current and voltage are freely programmable without any hardware variants. The allocation of measured variables to the outputs and the determination of the limits of the measuring ranges is also realised using the res-

Accessories

For configuration software see Page 60

Overview

Overview of the instrument families

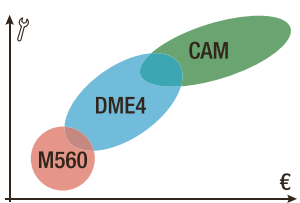
			
	SINEAX M56x	SINEAX DME4	SINEAX CAM
			
Measuring system			
Sampling values per system period	24	32	128 (continuously)
Accuracy class	0.5	Analogue outputs: 0.25 Measured variables of bus: 0.2	Basic instrument: 0.2 I/O modules: 0.1
Setting time (at 50 Hz)	≥ 1.0s, depending on the system configuration and the selected measured variables	≥ 0.3s, depending on the system configuration and the selected measured variables	≥ 0.06s
Nominal frequency	50/60 Hz	16.7 Hz, 50/60 Hz	45...65 Hz, 10...70 Hz, 10...140 Hz
Nominal current	1...6 A	1...6 A	1...5 A, Overriding up to 10 A
Nominal voltage	57.7...400 V (Ph-N) 100...693 V (Ph-Ph)	57.7...400 V (Ph-N) 100...693 V (Ph-Ph)	57...400 V (Ph-N) 100...693 V (P-P)
Measured variables			
Basic variables of the system ¹	•	•	•
Neutral wire current measurement			•
Meters		•	•
Tariff switching for meters			•
Unbalance			•
THD, TDD, harmonics			Up to the 50th harmonic
Maximum and minimum value with time stamp			•
Mean value acquisition			•
Logger for measured value progression			Option
Alarm / event / operator lists			Option
Display of measured values and lists, acknowledgement of alarms		Measured values + meters with accessory SINEAX A200	Option (internal or external)
I/O interface	fixed	fixed	modular (up to 4 modules)
Analogue outputs	1, 2 or 3	2 or 4	2 per module
Analogue inputs			2 per module
Digital outputs		4 or 2	3 per module
Digital inputs			3 per module
HV input 110/230 VAC			1 per module
Possible bus connections		RS485 (Modbus), Profibus, LON	As a standard: RS485 (Modbus) + USB Option: Ethernet IEC 61 850 or Modbus/TCP
Special software functions			
System check		•	•
Check of connection			•
Logic module			•

¹ The basic variables of the system are all single and system variables of voltage, current, bimetal current, active, reactive and apparent power, reactive and power factor as well as frequency

Camille Bauer Multi-Transducer M56x

Programmable multi-transducers

To measure up to 3 selectable variables in a heavy current system.



Customer benefit

- One measurement unit for up to three heavy current variables
- Fully programmable, therefore hardly any product variance. Reduced stocks
- Ideally suited to modernising existing plants
- EMC resistance far above legally stipulated limits
- PC software with password protection for configuration and commissioning
- Output signal(s) useable for display, registration and monitoring
- Safety through galvanic isolation of all circuits and shock-proof terminals

Application

The instruments of the programmable M56x transducer line are designed for measurement in electric distribution systems or industrial plants. User-defined measured variables can be issued via up to 3 bipolar, galvanically isolated analogue outputs and used for on-site display or the connection to a supervisory system (e.g. PLC). The area of interest may be highlighted by the scale function. The measuring system of the transducers has been designed for the acquisition of sinusoidal alternating current signals with low harmonic content. Contents up to the 11th harmonic are taken into consideration. These instruments are suited to measure after phase-angle controls or frequency converters only in a limited fashion. For very distorted signals or after full-wave controls the use of SINEAX CAM is recommended.

The transducer is connected via the PRKAB560 programming cable to the RS232 interface of the PC for programming. During commissioning, the output signals are simulated via PC software and measured values are retrieved and recorded.

Overview of instruments

Features	M561	M562	M563
Number of analogue outputs	1	2	3

Technical data

Meas. input: Nominal voltage 57.7...400 V (Ph-N) or 100...693 V (Ph-Ph)
Nominal current 1...6 A, nominal frequency 50 or 60 Hz

System

configuration: Single-phase alternating current, 3/4-wire three-phase current with a balanced/unbalanced load, also in reduced phase-shift connection (2 voltages, 1 current)

Meas. output: Maximum output value 20 mA or customised 1...20 mA or 5...10 V
Output signal unipolar, bipolar, live-zero
Transfer characteristics: Invertible, with/without step (scale function)
Measuring cycle time 0.6...1.6 s, depending on measured variable(s) and programming

Accuracy: Class 0.2 (voltage and current), Class 0.5 (other variables)
Applications in reduced phase-shift connection: double class

Power supply: 24-60 V AC/DC or 85-230 V AC/DC (also internally from measurement input)

H x W x D: 69.1 x 105 x 112.5 mm, top-hat rail assembly

Stock variants

Article No.	Type	Power supply (external)	Output signal
158 411	M561 with	24-60 V AC/DC	±20 mA
158 429	1 analogue output	85-230 V AC/DC	
158 437	M562 with	24-60 V AC/DC	
158 445	2 analogue output	85-230 V AC/DC	
146 458	M563 with	24-60 V AC/DC	
146 440	3 analogue output	85-230 V AC/DC	

Accessories

For M560 configuration software see Page 60, for PRKAB560 programming cable see Page 66

SINEAX M561/M562/M563



Programmable multi-transducer line DME4

To acquire several variables of any heavy current system simultaneously.

Customer benefit

- Only one measuring unit for several heavy current variables, Class 0.2
- Fully programmable, therefore hardly any product variance. Reduced stocks
- Up to 693 V nominal voltage (between phases) in CAT III
- Integrated energy meters with programmable measured variable
- PC software with password protection for configuration and commissioning
- Output signal(s) useable for display, registration, metering and monitoring
- Safety through galvanic isolation of all circuits and shock-proof terminals (SINEAX)

Overview of instruments

Type	DME442	DME424	DME406	DME400	DME401	DME440
Input	100...693 V (Ph-Ph), 1...6 A, 16.7 /50/60 Hz					
Accuracy	Analogue outputs: 0.25%, measured variables of bus: 0.2%					
Analogue outputs	4 bipolar [mA or V]	2 bipolar [mA or V]	—	—	—	4 bipolar [mA or V]
Digital outputs	2	4	—	—	—	—
Meter	up to 2	up to 4	4	4	4	4
Bus	—	—	Profibus DP	LON	Modbus	Modbus

General application

The instruments of the programmable DME4 transducer line are designed for measurement in electric distribution systems or industrial plants. They are used where a high degree of accuracy and flexibility is demanded. Depending on the instrument type, user-defined measured variables are issued at analogue or digital outputs or all acquired variables may be polled via the bus.

The measuring system of the transducers has been designed for the acquisition of sinusoidal alternating current signals with low harmonic content. Portions up to the 15th harmonic are taken into consideration. These instruments are suited to measure after phase-angle controls, for applications after frequency converters they can only be used in a limited fashion. For very distorted signals or after zero crossing controls the use of SINEAX CAM is recommended.

For a comprehensive measured value display on site, the SINEAX A200 display unit can be connected to the serial RS232 interface of the converter in all instrument types of the DME4 line. In this way, all instantaneous or meter values can be displayed.

The transducer is connected via a 1:1 cable to the RS232 interface of the PC for programming. During commissioning, possible output signals can be simulated via PC software. The complete

image of the system may be retrieved via the RS232 or a possible bus interface of the instrument, e.g. to check the correct connection.

Common technical data

Meas. input:	Nominal voltage 57.7...400 V (Ph-N) or 100...693 V (Ph-Ph), nominal current 1...6 A, nominal frequency 50, 60 or 16 $\frac{2}{3}$ Hz
System configuration:	Single-phase alternating current, 3/4-wire three-phase current with balanced/unbalanced load or 3-wire three-phase current with balanced load in reduced phase-shift connection (2 voltages, 1 current)
Measurement output:	Depending on instrument type, measuring cycle time 0.13...0.99 s, depending on instrument type and programming
Accuracy:	State variables via bus interface: Class 0.2, measured variables at analogue outputs: Class 0.25 Active power meters: Class 1, reactive power meters: Class 2 Applications with reduced phase-shift connection: double class
Power supply:	24–60 V AC/DC or 85–230 V AC/DC or AC supply 100, 110, 230, 400, 500, 693 V AC (only DME400, 424, 442), also internally from measuring input
H x W x D:	69.1 x 105 x 112.5 mm, top-hat rail assembly (35 x 15 mm or 35 x 7.5 mm) or plug-in card European format, face plate width 14 TE (EURAX DME 442, 440)

Accessories

- For DME4 configuration software see Page 60
- For RS232 programming cable (1:1 connection cable) see Page 66
- For 19" assembly rack for EURAX plug-in cards see Page 28
- For SINEAX A200, display unit for the DME4 line see Page 28

Camille Bauer Multi-Transducer Line DME4

Programmable multi-transducer

To acquire several variables of any heavy current system simultaneously.

For **general data** see „Programmable transducer line DME4“, Page 21



Overview of instruments

Features	DME424	DME442
Number of analogue outputs	2	4
Number of digital outputs	4	2

Application

The programmable multi-transducers DME424/442 can image several, freely programmable measured variables at analogue and digital outputs. The measured variables are allocated to the outputs by DME4 PC software. Analogue outputs may be used for on-site display or the connection to a supervisory system (e.g. PLC). The area of interest may be highlighted by the scale function (step). Complete suppression of the lower or upper range is also possible. Digital outputs may be used for the pulse output to external meters. Simultaneously, an internal meter reading is built which can be read via the RS232 interface. Digital outputs may also be used to monitor overruns or shortfalls of limit values. In addition, two outputs permit linking (AND/OR) of up to 3 limit values. During commissioning, the output signals can be simulated via PC software in order to test subsequent circuits also without an activated input. If digital outputs are used as limit values, the state can be specified, if used as a pulse output, a percentage of the set pulse rate.

Technical data

Analogue outputs

- Maximum value of the output 20 mA or customised 1...20 mA or 1...10 V
- Output signal unipolar, bipolar, live-zero
- Transfer characteristics: with/without step (scale function)
- Measuring cycle time 0.13...0.47 s, depending on measured variable(s) and system configuration, setting time 1...2 · measuring cycle time
- Accuracy 0.25c. Factor $c > 1$, if characteristic with a step or only parts of the input or output range are used.

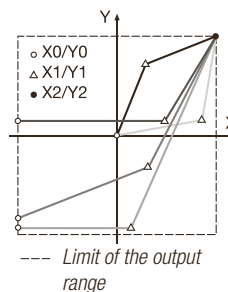

If the maximum values of the output of the instruments do not agree with the desired application, they can be reduced by software (possible additional error). The maximum values may also be adapted by hardware to the desired value or rearranged from current to voltage output (or vice versa). This requires that resistances in the instrument are changed and that outputs are recalibrated using the PC software.

Digital outputs

- Open collector outputs, 8...40 V externally supplied
- Output current 10...27 mA (ON) and 2 mA (OFF)
- If used as pulse output: Pulse duration and interpulse period ≥ 100 ms, suitable to energise mechanical meters.

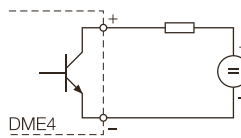

The pulse duration cannot be programmed. The accuracy of the pulse output corresponds to the class of the internal meters (see general data).

Stock variants

Article No.	Type	Power supply (external)	Output signals
129 206	DME442	230 V AC	± 20 mA
129 214		85–230 V AC/DC	
142 175		24–60 V AC/DC	

Variants for nominal frequency 50/60 Hz, without test protocol with basic configuration

Accessories

For accessories of the DME4 transducer line see Page 21

SINEAX DME424



SINEAX DME442



EURAX DME442



SINEAX DME401



SINEAX DME440



EURAX DME440



Programmable multi-transducer

Acquisition of all variables of any heavy current system with Modbus connection.

For **general data** see „Programmable transducer line DME4“, Page 21



Overview of instruments

Features	DME401	DME440
Number of analogue outputs	0	4
Modbus connection	yes	yes
Available in 19" rack version	no	yes

Customer benefit

The programmable DME401/440 multi-transducers can acquire all measured variables of any heavy current system. In addition, four user-determined measured variables can be output via analogue outputs in DME440.

DME4 PC software is used to allocate the measured variables to the analogue outputs of DME440 as well as setting input parameters. Analogue outputs may be used for on-site display or the connection to a supervisory system (e.g. PLC). During commissioning, the output signals can be simulated via PC software which facilitates a complete test of subsequent circuits.

Technical data

Analogue outputs

See DME442, however measuring cycle times up to 0.99 s if all measured variables of a 4-wire system with an unbalanced load shall be polled via Modbus

Modbus

Functions: Measured value acquisition and configuration of the converter, resetting of meters and slave pointers

Protocol: Modbus RTU

Physics: RS-485, max. line length 1200 m (4000 ft)

Baud rate: 1200, 2400, 9600 Bd

Number of

participants: max. 32 (including master)

Modbus

Modbus is ‚only‘ a protocol, i.e. instructions which state the sequence of characters which must be sent for a desired function and how the respective reply is structured. It can thus be used for any transmission medium, on principle. However, normally an RS-485 interface is employed since it is price-effective and permits the formation of a bus structure with several participants. The Modbus protocol is a single master protocol. This master (usually a PC or PLC) controls the complete transmission and monitors possibly occurring timeouts (no reply from the addressed device). The connected devices may send telegrams only if requested by the master.

Stock variants

Article No.	Type	Power supply (external)	Output signals
138 372	DME440 with 4 analogue outputs	85–230 V AC/DC	±20 mA
142 183		24–60 V AC/DC	
146 515	DME401 without analogue outputs	85–230 V AC/DC	—
146 523		24–60 V AC/DC	

Variants for nominal frequency 50/60 Hz, without test protocol with basic configuration

Accessories

For accessories of the DME4 transducer line see Page 21

Camille Bauer Multi-Transducer Line DME4

Programmable multi-transducer

Acquisition of all variables of any heavy current system with Profibus DP connection.



For **general data** see „Programmable transducer line DME4“, Page 21

Application

SINEAX DME406 is a freely programmable transducer with a PROFIBUS-DP interface. Profibus DP-V0 used in DME406 has been optimised for fast data exchange on the field level. All data and information required for the installation of the device is included in the Profibus CD which accompanies each instrument.

Technical data (Profibus DP-V0)

Bus connection: Screw connection on terminals 15 to 21
 Transmission rate: 9.6 kBaud ... 12 MBaud or automatic recognition of the baud rate
 Max. bus length: 100 ... 1200 m, depending on the baud rate and the cable used
 Interface: RS 485, galvanically isolated (500 V)
 Configuration: Via PC on site or via bus master

Stock variants

Article No.	Type	Power supply (external)
146 911	DME406	85–230 V AC/DC
146 896		24–60 V AC/DC

Variants for nominal frequency 50/60 Hz, without test protocol with basic configuration

Accessories

For accessories of the DME4 transducer line see Page 21

Programmable transducer

Acquisition of all variables of any heavy current system with LON connection.



For **general data** see „Programmable transducer line DME4“, Page 21

Application

SINEAX DME400 is a freely programmable transducer with a LONWORKS® interface. Instruments with a LON interface are primarily used in building automation.

Technical data LONWORKS® interface

Network protocol: LONTALK®
 Transmission medium: Echelon FTT-10A transceiver, transformer-coupled, reverse polarity protected, twisted two-wire cable
 Transmission speed: 78 kBit/s

LON (Local Operating Network)

LON is a fieldbus developed by Echelon Corporation of the US around 1990. LON technology facilitates the neutral exchange of information between plants and devices of different manufacturers.

Further instruments with a LON interface

EMMOD205, extension module A line, see Page 39
 A2000, multifunctional power transducer, see Page 33

Accessories

For accessories of the DME4 transducer line see Page 21

SINEAX DME406



SINEAX DME400



Universal measuring unit for heavy current variables

For the comprehensive analysis of any heavy current system.

Customer benefit

- Consistent measurement (without interruption)
- Suited to strongly distorted systems, zero crossing or phase-angle controls
- I/O interface adaptable to individual requirements
- Configuration and measured value acquisition via USB and Modbus interface
- Acquisition of minimum and maximum values with time stamp
- System analysis (harmonics and unbalance)
- Synchronisable real-time clock as a time basis and operating hour counter
- Graphic display with freely arranged measured value display and alarm handling (option)
- Logger for long-term recording of measured value progressions (option)
- Protocol lists for events, alarms and system messages (option)

Application

SINEAX CAM is designed for measurement in electrical distribution systems or industrial plants. Apart from the current system state, the pollution by non-linear loads as well as the overall load of the power system can be determined. Consistent measurement guarantees that any system change is reliably acquired and included in the measured data.

The high-performance measuring system makes the device also suitable for strongly distorted systems, zero crossing or phase-angle controls.

The I/O interface may be arranged as required. Up to 4 modules with different functionality may be used. The logger permits long-term recordings of measured value progressions, e.g. to monitor the variable load of transformers or to facilitate automatic meter readings. Lists record

definable events, alarms and system messages chronologically for a subsequent analysis of incidents in the power system.

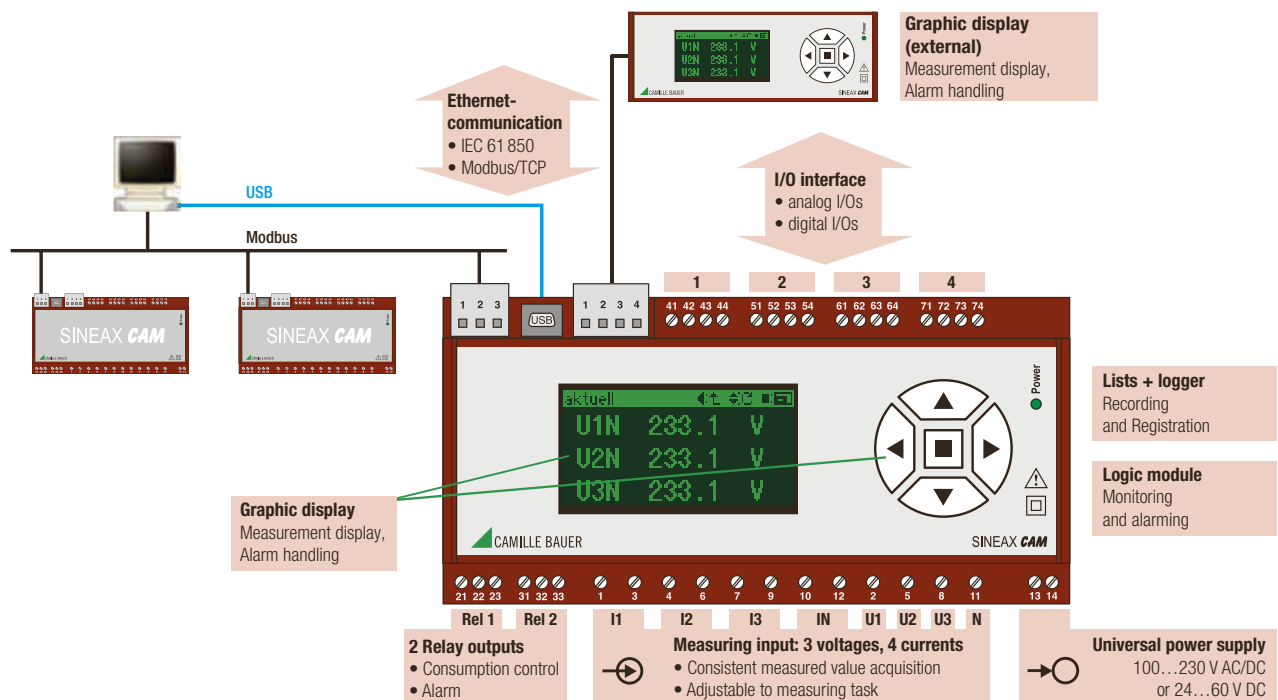

The optional 7-language graphic display (internal, external or both) is provided to visualise measured data and list entries on site. Users can adapt the display of measured data almost freely to their requirements. If required, a preferred display or an automatic

sequence of measured values may be defined. The selection of the measured value display, resetting of meters or extreme values but also the acknowledgement of alarm may be arranged via the keypad. The authorisation to execute such functions can be limited via a safety system

integrated in the device. If the system has been activated, the user must first log in via the display.

Camille Bauer Universal Measuring Unit CAM

Universal measuring unit for heavy current variables

Flexible I/O interface

I/O modules can be assembled according to individual needs. Up to 4 modules with selectable functionality may be used. Six different hardware modules are available.

Analog outputs ± 20 mA or 0/4...20 mA, 2 outputs per module

- On-site display via analog display units
- Heavy-current measurements for PLC

Analog inputs 0/4...20 mA, 2 inputs per module

- Acquisition of ext. quantities, e.g. temperature
- Automatic metering of input quantity
- Scalable, e.g. 4...20 mA to 0...100 °C, displayable on graphic display and requestable via interface

Digital outputs S0, 12/24 VDC, 3 outputs per module (switchable to inputs)

- Alarming output of the logic module
- State reporting
- Pulse output (S0) to external counter

Digital inputs, 3 inputs per module: 12/24 VDC (switchable to outputs)

- Acquisition of external state information
- Trigger or release signal for logic module
- Pulse input for metering

HV-input, 110/230 VAC, 1 input per module (only in position 4)

- Clock synchronization to system frequency
- Monitoring of voltage availability (ON/OFF)

Ethernet communication (option)

To be able to analyze the huge amount of measured data in real-time, a transmission medium with high bandwidth is necessary. Ethernet provides this high performance.

Option 1: Ethernet, Modbus/TCP protocol

Modbus/TCP is a commonly used protocol for an easy access to configuration or measurement data. It is supported by a large number of visualization software tools and thus allows a fast implementation of the device. NTP (Network Time Protocol) is supported for time synchronisation via Ethernet.

Option 2: Ethernet, IEC 61850 protocol

The communication standard IEC 61850 is the new standard for substation automation. Each possible device or system function is standardized and mapped in so called logical nodes (LN's). CAM provides the following logical nodes:

MMXU / MMXN: Instantaneous values of voltages, currents, frequency, powers and load factors as well as their maximum and minimum values. MMXU is used for asymmetrical 3 and 4 wire systems, MMXN for single phase and balanced load 3 and 4 wire systems.

MHAI / MHAN: Individual harmonics for voltages and currents, THD (total harmonic distortion) and TDD (total demand distortion) and their maximum values. MHAI is used for asymmetrical 3 and 4 wire systems, MHAN for single phase and balanced load 3 and 4 wire systems.

MMTR: Active and reactive energy meters for incoming and outgoing power. One instance for both high and low tariff.

MSTA: Mean values of voltage, current, active, reactive and apparent power as well as their maximum and minimum values on instantaneous values base. All measured within the same interval. These values are provided for each phase as well.

MSQI: Imbalance of voltages and currents, calculated in accordance with two different methods.

GGIO: Maps the information of assembled analog and digital input modules. For each input an instance of GGIO processes state information, a measured quantity or metering pulses from an external device.

SINEAX CAM



Analog output module

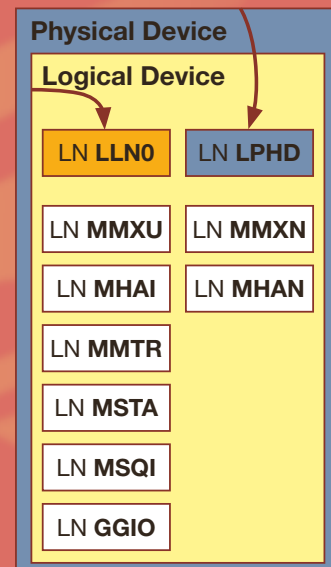

Universal measuring unit for heavy current variables

Data logger: Long-term recordings (option)

The data logger allows to perform long-term recordings of measurement progressions or load profiles, e.g. to monitor the variable load of transformers, feeders or transmission lines. In addition to the recording of mean-values, fluctuations of instantaneous values may be registered to recognize load peaks at the earliest possible moment.

By means of the automatic meter reading a time synchronous reading of the meter contents of all devices may be performed, e.g. on a weekly, monthly or three months base. These values can be stored for any desired time, thus allow determining the energy consumption per time for billing purposes.

Lists: Logging of alarms and events (Option)

Lists allow a chronological recording of events, alarms and system messages. Each change of the system state and each access to the device can thus be reproduced and analyzed at a later time in a correct sequence. Each entry in the lists is time stamped.

Logic module (standard):

The module consists of up to 32 logic functions with 3 digital input states each. Limit values of measured variables, states of digital inputs, state defaults via bus interface or results of other logic functions can be used as input variables. Typical applications are limit value monitoring of individual variables (e.g. overcurrent of a phase) or of combinations (e.g. phase failure). External functions can also be monitored via the I/O interface. The results of the logic functions will then trigger actions. This may be an alarm via digital outputs or relays but also an entry in an alarm or event list or the indication of an alarm text on the graphic display.

Technical data

Meas. input: Nominal voltage up to 693 V (Ph-Ph), nominal current up to 5 A, overridings programmable, nominal frequency 45...65 Hz, 10...70 Hz or 10...140 Hz
The device is also available with current inputs for Rogowski coils

System

configuration: Single-phase alternating current, split phase, 3/4-wire three-phase current with balanced/unbalanced load, clockwise and anti-clockwise rotating systems

Energy meter: Active energy incoming + outgoing, reactive energy incoming + outgoing + inductive + capacitive for measured system as well as max. 12 meters for external variables via digital or analogue inputs. All meters high and low tariff if tariff switching is activated

Accuracy: Voltage and current 0.1%, power and voltage unbalance 0.2%
Harmonics, THD and TDD 0.5%, power factor $\pm 0.1^\circ$, frequency ± 0.01 Hz
Active energy Class 1 (EN 62053-21), reactive energy Class 2 (EN 62053-23)
Analogue inputs/outputs $\pm 0.1\%$

Dimensions: 90 x 186 x 63 mm, assembly on top-hat rail (35 x 15 mm or 35 x 7.5 mm)

Standard interfaces (for configuration, service, measured value polling)

- Modbus/RTU connection, max. 32 participants (incl. master), baud raten up to 115.2 kBd
- USB connection (USB mini-B, 5-pole), protocol USB 2.0

Stock variants

Article No.	Type	Power supply (external)	I/O interface
158 726	SINEAX CAM	100 – 230 V AC/DC	Without
158 734			4 analogue outputs, unipolar

Variants for nominal frequency 50 Hz, without test protocol with basic configuration

Accessories

Article No.	Description
157 968	Graphic display EDS-CAM, for external control panel assembly
168 949	Connecting cable 2m EDS-CAM <> CAM, other lengths upon request
163 189	Interface converter USB <> RS485 (Modbus)

Part of the scope of delivery

For CB-Manager configuration software see Page 61

For CB-Analyzer analysis software for logger and lists see Page 61

EDS-CAM



Camille Bauer

Accessories for Transducer Line DME4

Display unit for transducer line DME4

Visualising of all measured variables of the DME4 transducers.

Customer benefit

- On-site display of all measurable variables of a DME4 transducer
- Resetting of meters and slave pointers without PC and software
- Replacement for numerous analogue displays
- Type of loading as 4 quadrant display
- Also available with top-hat rail adapter
- High-contrast, 14 mm LED display, good readability also from larger distances

Application

The display unit permits the indication of all measured data of a DME4 multi-transducer on site. This is particularly interesting for pure bus devices (Modbus, Profibus, LON, Ethernet) since the measured values can be checked in this ways without requiring a special bus visualising tool. In versions with analogue and digital outputs, this unit can also display all of those values which are not imaged at the outputs.

As soon as an A200 is connected to the serial interface of a DME4, the display begins reading out measured values. The direct connection of the devices and the purely digital data transmission achieve the high display accuracy of 0.1% (U, I) or 0.2% (P, Q, S).

Two versions are available depending on whether the display unit is only to be used during installation or whether it is supposed to be firmly installed as a cost-effective on-site display: The SINEAX A200 control panel installation device and the portable A200-HH version.

Technical data

Power supply: SINEAX A200: Wide range power unit 20–265 V AC/DC

A200-HH: Rechargeable Li-Ion battery,
24...90 h operating time depending on display intensity

Dimensions: SINEAX A200: 96 x 96 x 46 mm, assembly on top-hat rail via adapter is possible
A200-HH: 260 x 120 x 65 mm

Stock variants

Article No.	Type	Power supply (external)
154 063	SINEAX A200	20–265 V AC/DC
154 972	A200-HH complete	–

Accessories

Connecting cable Sub 9-pin male/male, Article No. 154 071 (in A200-HH included in the scope of delivery), see Page 66

Top-hat rail adapter for SINEAX A200, Article No. 154 055

19" Assembly Rack

for plug-in cards in European format.

Customer benefit

- Solder, wire-wrap or screw terminals
- Customised completely or partly assembled rack

Technical data

Power supply: 24–60 V AC/DC or 85–230 V AC/DC

SINEAX A200



SINEAX A200-HH



EURAX BT901



Content Displaying Power Meters

Overview	30
Displaying power meters, extendable by modules	
A210/A220	31
A230/A230s.....	32
Displaying power meters, „All in one“	
A2000	33
<i>APLUS</i>	34
Accessories for A210, A220, A230s, A230	
Overview	36
EMMOD201: RS232/RS485 interface + data logger	37
EMMOD202: 2 analogue outputs	37
EMMOD203: Ethernet interface + data logger	38
EMMOD204: Profibus interface.....	39
EMMOD205: LON interface	39
EMMOD206: M-Bus interface	40

Camille Bauer





Displaying Power Meters, Overview

Overview

The displaying power meters for heavy current variables are completely programmable, universal measuring units. They provide numerous measured values and permit the

complete acquisition of the state of a heavy current system. As is the case in multi-transducers, a sampling measuring principle is used (see overview of multifunctional

transducers). The table shown below is a selection guide for the right instrument.

				
	A210/A220	A230s/A230	A2000	A PLUS
	Display unit + optional extension module		„All in one“	
Measuring system				
Voltage, current	±0.5 %	±0.2 %	±0.25 %	±0.1 %
Apparent, active, reactive power	±1 %	±0.5 %	±0.5 %	±0.2 %
Active/reactive energy (IEC 62 053)				Class 0.5S / 2
Measuring interval	200 ms	200 ms	200 ms	2...1024 periods
Uninterrupted measurement				✓
Nominal voltage (max.) L-L	500 (600) V	500 (600) V	500 (550) V	690 (832) V
Nominal current (max.)	1 or 5 A (6 A)	1 or 5 A (6 A)	1 and 5 A (6 A)	1 and 5 A (7.5 A)
Measured variables				
Basic variables of the system ¹⁾	✓	✓	✓	✓
Mean values	1...60 min	1...60 min	1...60 min	1 s...60 min
Min/max values with time reference	with EMMOD...203	with EMMOD...203	✓	✓
Harmonic analysis		2. to 15.	2. to 15.	2. to 50.
Extended reactive power analysis				✓
Voltage phase angle				✓
System asymmetry		U (4L)		U + I (3L+4L)
Energy meter P/Q (HT/LT)	System	System	System, phase or HT/NT	System, phase (reference)
Universal meter via I/Os				✓ (max. 7)
Operating hour counter				3+1
Monitoring functions				
Limit values	2	2	2	up to 16
Boolean logic (logic module)				4 functions
Recording functions				
	with EMMOD...	with EMMOD...	(option)	(option)
Load profile (mean values)	201/203	201/203	✓	✓
Min/max values per interval		203	max	✓
Events / alarm				✓
Accident recording (RMS)			✓ (≥ 300 ms values)	✓ (≥ 2 period values)
Autom. meter readings				✓
Interfaces				
	with EMMOD...	with EMMOD...		
Ethernet	203	203	COM Server	✓ (option)
Profibus DP	204	204	✓	
Modbus	1.2...19.2 kBd	1.2...19.2 kBd	1.2...19.2 kBd	2.4...115.2 kBd
LON	205	205	✓	
M-Bus	206	206	✓	
Inputs/outputs				
	with EMMOD...	with EMMOD...		
Digital inputs	0, 1, 2	0, 1, 2	0, 1	1...7
Digital outputs	2	2	0, 2	1...7
Analogue outputs	0, 2	0, 2	2, 4	0, 4
Relay			2	1, 3
Display				
User-definable display		✓		✓
Limit value status display				4 LED's + plain text
Front W x H [mm]	96 x 96 / 144 x 144	96 x 96 / 144 x 144	144 x 144	96 x 96
Installation depth (with module)	46 (65)	46 (65)	59	105

¹⁾ All phase and system variables of voltage, current, active, reactive and apparent power, power factor as well as frequency

Camille Bauer Displaying Power Meters, Extendable by Modules

SINEAX A210



SINEAX A220



SINEAX A210-HH



Multifunctional power meter with display

For the complete acquisition of the system state of a three-phase heavy current system.

Customer benefit

- All relevant variables of a heavy current system with only one device
- Replacement for numerous analogue displays
- Large LED display which can be read from a distance
- 2 digital outputs for alarms or output to external counter mechanism
- Integrated active and reactive power meters, 5 interval times each for P, Q and S
- Functionality extendable with plug-in modules (bus connection, logger, analogue outputs)

Application

The instruments are designed for measurements in electrical distribution system or industrial plants. All parameters may be set via the display. Configuration can also be performed using A200plus software if an EMMOD201 (Modbus) or EMMOD203 (Ethernet) extension module has been temporarily or permanently plugged into the basic device.

The digital outputs cannot only be used to drive external counters but also for alarming in case of limit violations. If, for example, the measured variable of current is tested for exceeding a limit value, the same is triggered as soon as at least one of the phase currents exceed the limit value. A limit value on the neutral wire helps to minimise the risk that an undersized neutral wire causes insulation damage or even fires. An extension module may be plugged in to connect supervisory systems or to network devices via Modbus, Profibus, LON or Ethernet.

For mobile use, A210 is also available in a handheld version. A210-HH with data logger is provided in a case including voltage measuring cables, software, battery and system adaptor. Also clip-on current transformers are available, if required.

Technical data

Meas. input: Nominal voltage 500 V (Ph–Ph), nominal current 1/5 A, nominal frequency 50/60 Hz
System

configuration: Single-phase alternating current, 3/4-wire three-phase current with balanced / unbalanced load

Display: 3 digits + sign, frequency 4-digit, meter 8-digit

Accuracy: Voltage and current $\pm 0.5\%$, power, power factor, energy $\pm 1.0\%$
frequency ± 0.02 Hz (absolute). All details refer to nominal values

Power supply: 100–230 V AC/DC or 24–60 V AC/DC

Dimensions: A210: 96 x 96 x 46 mm, A220: 144 x 144 x 46 mm

Assembly on top-hat rail with adaptor (Article No. 154 055) is possible

Stock variants

Article No. A210	Article No. A220	Input	Power supply	Test protocol	Mounted extension module	
149 783	152 546	500 V / 5 A	100–230 V AC/DC	without	without	
150 300	152 554		24–60 V AC/DC			
150 318	152 562	500 V / 5 A	100–230 V AC/DC	with		
150 326	152 570		24–60 V AC/DC			
152 447	152 588	500 V / 1 A	100–230 V AC/DC	without		
152 702	152 736		24–60 V AC/DC			
152 710	152 752	500 V / 1 A	100–230 V AC/DC	with		
152 728	152 744		24–60 V AC/DC			
159 451		500 V / 5 A	100–230 V AC/DC	without		EMMOD201 (Modbus)
159 469						EMMOD203 (Ethernet)
158 635	158 643				EMMOD204 (Profibus)	

Accessories

For extension module EMMOD20x see Pages 36-40

For configuration software A200plus see Page 60

For interface adapter cable RS232 see Page 66

Camille Bauer

Displaying Power Meters, Extendable by Modules

Multifunctional power meter with display

Complete acquisition and analysis of the system state of a three-phase heavy current system.

Customer benefit (in addition to A210 / A220)

- System can be analysed in relation to unbalance of voltages
- Determination of individual harmonic contents and THD
- 3 different modes for specific measured value display
- Additional mean values also for non-power variables including trend analysis

Application (see also A210/A220)

Electrical distribution systems and industrial plants are increasingly subjected to non-linear loads like computers or electronically controlled motors. This might lead to premature fuse blow-outs, overload of the neutral wire or malfunctions of devices. A230s/A230 is able to determine this additional load.

The harmonics analysis assesses whether an active correction to improve the system quality is required. Special consideration should be given to the current harmonics of the 3rd, 9th and 15th order which add up in the neutral wire.

Using the system unbalance the load of a transformer may be analysed. If the same is unbalanced loaded under nominal load this will lead to compensating current and thus to additional heating. The consequence may be damage to the insulation or even the destruction of the transformer.

For mobile use, A230s is available in a handheld version. A230-HH (Modbus) or A230E-HH (Ethernet) is provided in a case including a voltage measuring cable, software, battery and system adaptor.

Technical data

Meas. input: Nominal voltage 500 V (Ph-Ph), nominal current 1/5 A, nominal frequency 50/60 Hz
System

configuration: Single-phase alternating current, 3/4-wire three-phase current with balanced/unbalanced load, also in Aron or open-Y measuring circuit available

Display: 4 digits + sign, meter 8 digit, display mode programmable

Accuracy: Voltage and current $\pm 0.2\%$, power, power factor, energy $\pm 0.5\%$, frequency ± 0.02 Hz (absolute). All details refer to nominal values

Power supply: 100–230 V AC/DC or 24–60 V AC/DC

Dimensions: A230s: 96 x 96 x 46 mm, A230: 144 x 144 x 46 mm
Assembly on top-hat rail with adaptor (Article No. 154 055) is possible

Stock variants

Article No. A230s	Article No. A230	Input	Power supply	Test protocol	Mounted extension module
154 782	152 942	500 V / 5 A	100–230 V AC/DC	without	without
154 766	152 926		24–60 V AC/DC		
154 790	152 950	500 V / 5 A	100–230 V AC/DC	with	
154 774	152 934		24–60 V AC/DC		
154 740	152 900	500 V / 1 A	100–230 V AC/DC	without	
154 724	152 885		24–60 V AC/DC		
154 758	152 918	500 V / 1 A	100–230 V AC/DC	with	
154 732	152 893		24–60 V AC/DC		
161 472	earth fault monitoring in unearthed 500 V IT system		24–60 V AC/DC	without	
159 477	152 968				
158 657	155 649	500 V / 5 A	100–230 V AC/DC	without	EMMOD203 (Ethernet)
158 669	158 651				EMMOD204 (Profibus)
161 480	161 472 with EMMOD205 (156647)			without	EMMOD205 (LON)

Accessories

For extension module EMMOD20x see Pages 36-40

For configuration software A200plus see Page 60

For interface adapter cable RS232 see Page 66

SINEAX A230s



SINEAX A230



SINEAX A230-HH
SINEAX A230E-HH



Gossen Metrawatt

Displaying Power Meters, „All in one“

SINEAX A2000



A2000 Mobil-Set



Multifunctional power transducer with display

Complete acquisition and analysis of the state of a three-phase heavy current system.

Customer benefit

- All relevant variables of a heavy current system with only one device
- Measurement of harmonics and harmonic distortion
- Determination of the neutral wire current
- Continuous measured value recording for load profiles and statistical purposes (option)
- Fault recorder with fast recording of events with a predefault event (option)

Application

The instrument serves the analysis of alternating current systems and is used where conventional instruments cannot meet the growing requirements in distribution systems. This is particularly the case where apart from current, voltage and power also the harmonic distortion and harmonics are of importance.

Further usage comprises applications in which instruments are to be replaced simultaneously with conventional recorders and fault indicators. Combined with current and voltage converters, the device measures the most important low and medium voltage facilities.

Analogue outputs, limit values and interfaces are available to monitor and process the measured values. The data storage variant records the chronological progression of up to 12 measured values simultaneously and safe in relation to a system failure. Important measured values may be continually recorded for long periods of time or, alternatively, recording is triggered by an event for a determined period of time.

In event-controlled recording, the predefault event leading to the event can also be recorded with the same speed. You thus get a very good overview of the predefault event leading to the event. The instrument thus meets the requirements of a fault indicator considerably better than conventional paper recorders were ever able to do. A2000 is also available in a **mobile variant**. The A2000 power instrument is installed in a stable case, incl. alligator clips for voltage measurement inputs, RS232 interface and parameterising and analysing software METRAWin 10 for A2000. There is also space in the case for the optional clip-on current transformer.

Technical data

Meas. input: Nominal voltage 500 V (Ph–Ph), nominal current 1 + 5 A, nominal frequency 40...70 Hz

System

configuration: 3/4-wire three-phase current with balanced/unbalanced load also in Aron measuring circuit

Display: 4 digits + sign, meter 9 digit

Accuracy: Voltage and current $\pm 0.25\%$, power, energy $\pm 0.5\%$, power factor ± 0.02 , frequency ± 0.02 Hz (absolute). All details refer to nominal values

Power supply: 230/115 V AC or 20–69 V AC / 20–72 V DC or 73–264 V AC / 73–276 V DC or 20–27 V AC, 20–36 V DC

Dimensions: Front 144 x 144 mm, installation depth 59.1 mm
Assembly on top-hat rail possible with adaptor

Stock variants

Article No.	I/Os	Interface	Data logger
A2000-V001	2 analogue outputs	RS232 + RS485	without
A2000-V002	4 analogue, 2 pulse outputs, 1 synchronised input		with
A2000-V003	2 analogue, 2 pulse outputs, 1 synchronised input	RS232 + LON	without
A2000-V004	2 pulse outputs, 1 synchronised input	RS232 + Profibus DP	

All variants for 500 V / 1 + 5 A, power supply 230/115 V AC, with software, without test protocol

Accessories

Configuration software METRAWin10 / A2000 (included in the scope of delivery)

COM Server

RS232-USB interface converter Z501L

Camille Bauer

Displaying Power Meters, „All in one“

Multifunctional power meter with display

Measurement, monitoring and power quality analysis in power systems.

Fields of application

The *APLUS* is a comprehensive instrument for the universal measurement, monitoring and power quality analysis in power systems. The focus is on highest Swiss quality and maximum customer benefit.

The device is suited for the application in power distribution, in strongly distorted industrial environments and in building automation. Nominal voltages up to 690 V can directly be connected. The connection of the process environment may be performed by means of the communication interface, via digital I/Os or via analog outputs.

Possible applications in power systems

- Acquisition and control of the present system state
- Monitoring of the operational behaviour
- Analysis of the power quality
- Determining load profiles and energy demand values
- Finding the variations of the system load
- Measurement before and behind frequency converters
- Recording of operating procedures

Measurement of power quantities.

The *APLUS* can be adapted fast and easily to the measurement task by means of the CB-Manager software. The universal measurement system of the device may be used directly for any system, from single phase up to 4-wire unbalanced networks, without hardware modifications. Independent of measurement task and outer influences always the same high performance is achieved.

The measurement is performed in all four quadrants and can be adapted to the system to monitor in an optimal way. The measurement time as well as the expected system load can be parameterized.

Logic module: Monitoring of operating behaviour.

To effectively protect operating resources it must be assured that multiple system quantities are within their allowed range. The logic module offers a comfortable facility to combine multiple limit values and to trigger further actions such as alarming, event registration or disturbance recording.

To monitor the operating time of specific loads up to three operating time counters are supported, which are controlled by means of limit values or digital operating feedbacks.

Possible applications of the logic module are:

- Function of protective relays (e.g. over-current, phase failure or imbalance)
- Changeover of the present operating mode, such as local/remote (day/night) operation
- Controlling the recording of alarms, events and acknowledgment procedures
- Monitoring of external devices: circuit states or self monitoring signals

Power quality analysis instead of failure analysis.

But what's really needed when monitoring power quality is a statement if the used operating resources will work undisturbed under the real existing conditions.

The *APLUS* therefore does not work with statistics, but examines the real environment, to allow performing a corresponding immunity analysis.

- Variation of the system load
- System imbalance
- Additional load by harmonics
- Violations of limit values
- Fundamental and distortion reactive power

APLUS



Multifunctional power meter with display

The display

The *APLUS* offers all which is requested from a device with display:

- Excellent legibility from almost any distance and each angle
- Clear and explicit display of measured data
- Free composition of measurement displays
- Free allocation of alarms to status LED's
- Free definable plaintext display for alarming
- Preference display and roll mode

Free composition of the required functions

The *APLUS* basic unit is already comprehensively equipped with a relay output for alarming, a digital output, e.g. for pulse output, and a digital input, e.g. for tariff switching.

For applications where this is not sufficient, the optional I/O extensions 1 or 2 are available:

- I/O extension 1: 2 relays, 4x ± 20 mA (galvanically isolated), 2 digital I/O's 12/24 V DC
- I/O extension 2: 2 relays, 6 digital I/O's 12/24 V DC

The digital I/Os of the I/O extensions can be configured individually as inputs or outputs.

Parametrization, service and measurement acquisition

These functions are facilitated by the included CB-Manager software. A security system can be activated to restrict the access to device data. This way e.g. changing a limit value via display can be locked, but a setting via configuration could still be possible.

A Modbus/RTU interface (RS-485) or an optional Ethernet interface with Modbus/TCP protocol are available for communication.

Data logger (option)

The optional data logger can be used for the non-volatile storage of measured value progressions (e.g. load profiles), events, alarms, meter readings and disturbance recordings. The SD card used for storage may be replaced on-site. For a tabular or graphical analysis of the recorded data the CB-Analyzer software is available.

Technical data

Measuring input : Nominal voltage up to 693 V (PH-Ph), nominal current up to 5 A, override up to 7.5 A programmable, nominal frequency 50/60 Hz

Systems: Single-line AC, split phase, 3/4 wire rotary current balanced / unbalanced load, rotating clockwise and counter-clockwise

Energy meter: Active energy incoming+outgoing, reactive energy incoming+outgoing+inductive+capacitive for measured system as well as incoming active and reactive energy per phase, max. 7 meters for external variables via digital inputs. High and low tariff for all meters, if tariff switching is active.

Accuracy: Voltage and current 0.1%, power and voltage asymmetry 0.2% harmonics, THD and TDD 0.5%, power factor $\pm 0.1^\circ$, frequency ± 0.01 Hz
Active energy Class 0.5S (EN 62 053-22), reactive energy Class 2 (EN 62 053-23)
Analogue outputs $\pm 0.2\%$

Dimensions: 96 x 96 x 105 mm

Accessories

Article No.	Description
163 189	Interface converter USB \leftrightarrow RS485

Part of the scope of delivery

For CB-Manager configuration software see Page 61

For CB-Analyzer analysis software for logger and lists see Page 61

Camille Bauer

Accessories for A210, A220, A230s, A230

Overview

The extension modules enlarge the functionality of the A210, A220, A230s and A230 power monitors. They can be simply snapped onto the back of the basic instrument and take their power supply from it.

Functionality EMMOD...	201	202	203	204	205 typ A	205 typ E	206
Interface							
• RS232/RS485 (Modbus/RTU)	•						
• Ethernet (Modbus/TCP)			•				
• Profibus DP (RS485)				•			
• LON (communication with U160x)					•		
• LON (standard)						•	
• M-Bus							•
Data logger							
• Mean-values	≤ 2		≤ 14				
• Min/max interval values (A230s / A230 only)			≤ 9				
• Time reference via PC time	•						
• Time reference via built-in RTC			•				
Outputs							
• Analog outputs 0/4..20 mA		2					
• Digital output 125 V DC					1		
Digital inputs							
• Synchronization pulse for mean-values			1				
• Tariff switching HT/LT			1				
• Synchronization or HT/LT	1					1	1
Parametrization of the module							
• via software A200plus	•						
• via basic device		•			•	•	•
• via GSD in the control system				•			
• via software A200plus and browser			•				

All devices of the A series (A210, A220, A230s, A230) can be equipped with an adapter for mounting on top-hat rail. If the basic device is also equipped with an extension module, in addition a set with longer fixing clips is required, to allow the fixing of the top-hat rail adapter.

Accessories

Top-hat rail adapter for A210, A220, A230s, A230, Article No. 154 055

Fixing clips as set (4 pieces) for top-hat rail adapter with extension module, Article No. 154 394

EMMOD201



Extension module Modbus, data logger, synchronised input

For power instruments A210, A220, A230s, A230.

Customer benefit

- Switchable interface RS232 / RS485 (Modbus) for configuration and measured value display
- Networking of up to 32 devices via RS485
- Digital input for tariff switching or external synchronisation of billing intervals
- Load profile storage: For 15 min mean values, recording up to 166 days
- Data logger for progression of mean values (only with A230 and A230s)

Application

The EMMOD201 extension module is simply snapped onto the back of the A210, A220, A230 or A230s power instrument and is supplied with power by the same. Parameterising is completely performed via the A200plus PC software.

Technical data

Connections: Pluggable screw terminals

Data logger: 16'000 mean values, up to 166 days (1 mean value with 15 min intervals)

A210/A220: Active power mean value input-output, reactive power mean value inductive+capacitive

A230s/A230: Active power mean value input/output, reactive power mean value inductive/capacitive or input/output, apparent power mean value, up to 9 further mean values freely selectable

Article No.	Description
150 285	Extension module EMMOD201

For retrofitting. For mounted version see the respective basic instrument.

EMMOD202



Extension module 2 analogue outputs

For power instruments A210, A220, A230s, A230.

Customer benefit

- 2 analogue outputs, e.g. for the connection to a PLC

Application

The EMMOD202 extension module is simply snapped onto the back of the A210, A220, A230 or A230s power instrument and is supplied with power by the same. The analogue outputs are programmed via the keys on the device.

Technical data

Number of channels: 2, galvanically isolated

Output: 0...20 mA, 4...20 mA, invertible

Connections: Pluggable screw terminals

Limitation: 0/3.7 mA or 21 mA

Load voltage: 8 V

Accuracy: $\pm 0.1\%$ (without A2xx)

Measured variables: A210/A220: U, I, Iavg, In, P, Q, S, F, PF

A230s/A230: Additional voltage and current mean value, zero shift voltage, unbalance factor, THD U, THD I

Article No.	Description
155 574	Extension module EMMOD202

For retrofitting.

Camille Bauer

Accessories for A210, A220, A230s, A230

Extension module Ethernet, data logger, real-time clock

For power instruments A210, A220, A230s, A230.

Customer benefit

- Fast communication via Ethernet (Intranet or Internet)
- Measured data via Modbus/TCP accessible
- Browser interface for system parameterising and measured value acquisition
- Data logger with synchronisable time reference
- 2 digital inputs for synchronised pulse and tariff switching
- Device installation, device configuration, measured value display, graphic logger analysis using PC software A200plus

Application

The EMMOD203 extension module is simply snapped onto the back of the A210, A220, A230 or A230s power instrument and is supplied with power by the same. The module may be retrofitted without interference with the basic device.

The EMMOD203 module supplements the functionality of the basic A2xx device by an Ethernet interface, a data logger as well as a real-time clock as a time reference. It facilitates the exchange of data with a control system via Modbus/TCP and HTTP.

The data logger permits the non-volatile storage of progressions of mean values and min/max values (RMS) during the averaging interval with a time stamp. This enables load profile records which are synchronised with the billing interval of the energy provider. The reference is not lost in a power failure. This is contrary to EMMOD201 where the time reference for the acquired values is subsequently related to the current PC time.

EMMOD203 is equipped with 2 digital inputs which may be used for tariff switching (high/low tariff) and for the synchronisation of the real-time clock with the system frequency or as a standardised control signal.

The A200plus software and a network-compatible PC are required for the configuration of the basic A2xx device. Certain parameters of the network settings but also the source for the synchronisation of the real-time clock are set via the browser interface of EMMOD203.

Technical data

Connections

- Ethernet: 10/100 Base Tx, RJ45-Port
Synchronised input: 5 V...300 V AC, 1...500 Hz, pluggable screw terminals
Tariff switching: 5 V...300 V AC/DC, pluggable screw terminals

Data logger

- Storage depth: max. 37'500 mean values, up to 390 days (1 mean value with 15 min intervals)
Format: Binary (ASN. 1 BER)
Measured variables: A210/A220: Active power mean value input-output, reactive power mean value inductive+capacitive
A230s/A230: Active power mean value input/output, reactive power mean value inductive/capacitive or input/output, apparent power mean value, up to 9 further mean values freely selectable, up to 9 min/max values (RMS) within the averaging interval

Real-time clock

- Buffering: with Battery, power reserve 2 years
Synchronisation: Via the network with TIMEP (RFC738) or SNTP (RFC2030), synchronised input on the system frequency (50/60 Hz) or an external ripple control signal. Configuration via WEB page.

Article No.	Description
155 582	Extension module EMMOD203

For retrofitting. For mounted version see the respective basic instrument.

Further instruments with an Ethernet interface

- APLUS with Ethernet interface option, see Page 34
SINEAX CAM with Modbus / TCP or IEC 61 850, see Page 26
A2000 with COM Server, multifunctional power transducer with display, see Page 33

EMMOD203



EMMOD204



Extension module Profibus DP

For power instruments A210, A220, A230s, A230.

Customer benefit

- Cyclic transmission of the desired process image or system state
- Simple and fast commissioning

Application

The EMMOD204 extension module is simply snapped onto the back of the A210, A220, A230 or A230s power instrument and is supplied with power by the same. Parameterising uses GSD. All instrument parameters can be engineered in the control system. On site, only the slave address is set. Required measured data is determined during engineering and arranged as a fixed process image (up to 34 measured value modules). All instantaneous values as well as meter readings are available as measured variables for selection. After the acquisition of the configuration, the device transfers the process image cyclicly to the control system.

Technical data

Connection: 9-pin D-sub socket, EIA RS485 standard, 15 kV ESD protection
Type: DPVO, SPC4-2. Baud rate automatic or 9600 bit/s to 12 Mbit/s

Article No.	Description
158 510	Extension module EMMOD204

For retrofitting. For mounted version see the respective basic instrument.

Further devices with Profibus DP interface

For DME406, programmable multi-transducer with Profibus-DP interface, see Page 24
For A2000, multifunctional power transducers with display, see Page 33

EMMOD205



Extension module LON

For power instruments A210, A220, A230s, A230.

Customer benefit

- Instantaneous values and meter readings can be acquired via LONTALK protocol
- Direct connection to the U160x summator of Gossen-Metrawatt is possible

Application

The EMMOD205 extension module is simply snapped onto the back of the A210, A220, A230 or A230s power instrument and is supplied with power by the same. The basic instruments are parameterised via keys on the device. Alternatively, EMMOD201 or EMMOD203 can be snapped on first of all to enable programming via a PC and subsequently a change to EMMOD205 is made.

Technical data LONWORKS® Interface

Network protocol: LONTALK®
Transmission medium: Echelon FTT-10A Transceiver, transformer-coupled, reverse polarity protected, twisted two-wire cable
Transmission speed: 78 kBit/s
Connections: Pluggable screw terminals

Article No.	Description
156 639	Extension module EMMOD205 with synchronous input
156 647	Extension module EMMOD205 with digital output 125 V, connection to U160x of Gossen-Metrawatt possible

For retrofitting. For mounted version see the respective basic instrument.

Further instruments with a LON interface

DME400, programmable multi-transducer with LON interface, see Page 24
A2000, multifunctional power transducer, see Page 33

Camille Bauer

Accessories for A210, A220, A230s, A230

Extension module M-Bus

For power instruments A210, A220, A230s, A230.



Customer benefit

- Information on energy consumption and instantaneous values via M-Bus protocol
- Digital input for tariff switching or external synchronisation of billing intervals

Application

The EMMOD206 extension module is simply plugged onto the back of the A210, A220, A230 or A230s power instrument and supplied by the same. The basic instruments can be parameterised via keys at the device itself or via the M-Bus.

Available measured values

The measured data to be transferred in the M-Bus protocol may be combined from the following measured variables:

- Active energy meter incoming / outgoing
- Reactive energy meter incoming / outgoing or inductive / capacitive
- Mean power values incoming active power and incoming reactive power
- Instantaneous values voltage, current, power, power factor and frequency

Technical data

System protocol:	M-Bus according to EN 13757
Transmission medium:	M-Bus according to EN 13757
Transmission rate:	300 baud up to 38.2 kbaud
Connections:	Pluggable screw terminals

Article No.	Description
168 965	Extension module EMMOD206

For retrofitting.

Further instruments with M-Bus interface

U128x and U138x – active energy meter, see Page 43

EMMOD206



Content Energy Management

Energy meters

Overview	42
U1281	43
U1381	43
U1387	43
U1289	43
U1389	43
U398A	45
U398B	45

ECS Energy Control System

Overview	46
----------------	----

Summators

Overview summators.....	47
U1600	48
U1601	49
U1602	50
U1603	51
Overview ECS with SMARTCONTROL	52
U200, SMARTCONTROL ECS.....	53

Additional components for summators

Additional components	55
-----------------------------	----

Load optimisation

U1500	56
-------------	----

Power quality

Mavolog 10	57
Mavosys 10.....	58

Software for energy management

Z302B, Z302C, Z302B.....	62
ECSwin, configuration software for U160x summator	62
ECSopt, load optimising module for ECSwin.....	63
U1600 Excel-Makro	63
EMC, energy management with system	64
Encore Series	65

Gossen Metrawatt Energy Meters

Overview energy meters

Description		Article No./characteristic						
Active energy meter for 2-wire system, direct, class 1				U1281				
Active energy meter for 4-wire system, direct, any load, class 1		U389A			U1289			
Active energy meter for 2-wire system, transformer, class 1						U1381		
Active energy meter for 3-wire system, transformer, any load, class 1							U1387	
Active energy meter for 4-wire system, transformer, any load, class 1			U389B					U1389
System frequency	50 Hz	•	•	F0	F0	F0	F0	F0
	60 Hz	–	–	F1	F1	F1	F1	F1
External voltage supply 24 V DC	without	–	–	H0	H0	H0	H0	H0
	with	–	–	H1	H1	H1	H1	H1
Multifunctional design with additional measurement of U, I, P, Q, S, PF, f	without	–	–	M0	M0	M0	M0	M0
	with	–	–	M1	M1	M1	M1	M1
Design value of input voltage Ur	100–110 V P–P	–	–	–	–	–	U	8
	230 V P–N	–	–	U	5–	U	5–	–
	400 V P–P	•	•	–	U6	–	U6	U6
	500 V P–P	–	–	–	–	–	U	7–
Calibration	without	•	•	P0	P0	P0	P0	P0
	Approval D, calibration	–	–	P1	P1	P1	P1	P1
	Approval D, calibration and calibration certificate	–	–	P2	P2	P2	P2	P2
	Approval CH			P3	P3	P3	P3	P3
	Approval AT	–	–	–	P4	–	P4	P4
	Approval CZ			P5	P5	P5	P5	P5
	English type plate	–	–	P6	P6	P6	P6	P6
Approval HR			P7	P7	P7	P7	P7	
Pulse output		–	–	V0	V0	V0	V0	V0
S0, 1000 pulses/kWh, calibratable	S0-Standard	–	•	V1	V1	V1	V1	V1
S0, 100 pulses/kWh	S0-Standard	•	–	–	–	–	–	–
S0, rate, duration programmable	S0 programmable	–	–	V2	V2	V2	V2	V2
Switching output up to 230 V, 1000 pulses/kWh, calibratable (not H1)	Pulse 230 V Standard	–	–	V3	V3	V3	V3	V3
Switching output up to 230 V, rate, duration programmable (not H1)	Pulse 230 V programmable	–	–	V4	V4	V4	V4	V4
Bus connection	without	•	•	W0	W0	W0	W0	W0
	LON	–	–	W1	W1	W1	W1	W1
	M-Bus	–	–	W2	W2	W2	W2	W2
	L-Bus	–	–	W3	W3	W3	W3	W3
Transformer ratios								
Current/voltage fixed, main display calibratable	CT=VT=1	–	•	–	–	Q0	Q0	Q0
Current/voltage programmable, secondary display calibratable	CT, VT programmable	–	–	–	–	Q1	Q1	Q1
Current/voltage firmly set, main display calibratable CT=1...10000, VT=1...1000, CTxVT ≤ 1 Mio.	CT, VT fixed	–	–	–	–	Q9	Q9	Q9

Overview of design approvals for billing

Country	Authority	Approval No.	U1281	U1289	U1381	U1387	U1389
D	PTB	Physikalisch Technische Bundesanstalt	20.15.04.27	•	•	•	•
A	BEV	Bundesamt für Eich- und Vermessungswesen	OE05 E040		•		
			OE05 E050			•	•
CH	metas	metrologie und akkreditierung schweiz	EC2 06570-00	•	•	•	•
CZ	CMI	Cesky Metrologicky Institut	TEU 221/04-4127	•	•	•	•
HR	DZNM	Croatian State Office for Standardization and Metrology	HR F-6-1057	•	•	•	•

Obligatory calibration for energy meters

Energy meters in commercial or official use are subject to obligatory calibration. The legal basis is the calibration act to protect consumers. It governs the approval and calibration obligation of instruments and is always to be adhered to if the acquisition of electric energy is the basis for energy cost billing to third parties. In-house cost distribution is excluded.

Meter and calibration from the same source

Gossen-Metrawatt has a state-registered test office for electric instruments and can supply energy meters and calibration for Germany from the same source.



Calibration sign



U1281, U1381



Alternating current, 2-wire system

U1387



Three-phase current, 3-wire system

U1289, U1389



Three-phase current, 4-wire system

Electric energy meter with power display

Acquisition of active energy in 4-wire three-phase systems according to EN 61 036.



Customer benefit

- Precise active energy measurement according to EN 61 036, class 1
- Calibration capability, suited to official billing
- Display of instantaneous power
- Extendable for additional system measurement variables
- Direct connection 5(65) A, without additional current transformers
- Transformer connection 5//1 A
- Transformer ratios can be set and calibrated
- Variant for 60 Hz system frequency available
- Display of installation errors without additional measuring equipment
- Pulse output 50 or 230 V
- Adjustable pulse rate and pulse duration
- Compact design requires little space
- Optional LON, M-bus, L-bus interface
- Optional reading while electrical circuit is switched off

Application

The energy meters may be universally used for the acquisition and billing of electrical energy in trade, household, industry and building management applications. Momentary circuit loads can be evaluated at any time using the additional instantaneous power display. Variants for direct connection (U1281, U1289) are designed for currents up to 65 A without the installation of additional current transformers. The variants for transformer connection (U1381, U1387, U1389) may be connected both to x/1 A and x/5 A current transformers.

Integrated error recognition for incorrect rotary field direction, missing phases, reverse-poled current transformers, measuring range overloads and missing bus connections saves valuable time and test equipment during troubleshooting.

More transparency in operation

In addition to active energy and instantaneous power, the multifunctional variant (M1) also displays individual *currents, voltages, active, reactive and apparent power, power factors and frequency* by simply pressing a key. Voltage level, phase utilization, reactive power component and compensation can thus be continuously evaluated during operation.

Universal bus connection

The energy meters transmit meter readings and other data to data logging, billing and optimizing systems, as well as building automation and control technology applications, via optional interfaces.

- LON interface with FTT-10A transceiver (W1)
- M-Bus interface according to EN 1434-3 (W2)
- L-Bus interface for battery-operated HYDRO-RADIO 868 radio module (W3)

Diverse calibration capability – approval for official billing

The energy meters can be supplied as calibrated variants (P1), and additionally with calibration certificate (P2), for official energy billing. According to legal requirements, the calibration certificate may not show any deviation in measurement. Depending upon requirements, the following variants are possible

- *Calibrated main display for primary energy*, calibrated pulse output with reference to primary energy and a fixed pulse rate of 1000 pulses/kWh (V1, V3) – directly measuring variant
- *Calibrated main display for primary energy*, transformer ratios stated upon ordering are fixed (Q9) and calibrated, calibrated pulse output with reference to primary energy and a fixed pulse rate depending on CTxVT (V1, V3)
- *Calibrated main display for secondary energy*, fixed transformer ratios $CT=VT=1$ (Q0), calibrated pulse output with reference to secondary energy and a fixed pulse rate of 1000 pulses/kWh (V1, V3)
- *Uncalibrated main display for primary energy*, adjustable transformer ratios (Q1) in combination with a calibrated ancillary display for secondary energy, calibrated pulse output with reference to secondary energy and a fixed pulse rate of 1000 pulses/kWh (V1, V3)

Electric energy meter with power display

Meter reading and bus operation while the electric circuit is switched off

The meter can be optionally equipped with a 24 V DC auxiliary power input (H1) for assured discharge-free voltage, which allows for direct meter reading, or remote meter reading for bus compatible variants, even when the electrical circuit is switched off. The use of a UBAT-24V battery pack permits meter readings without continuously active supply power.

Technical data

Meas. input: Nominal voltage 100–110 V (P–P), 230 V (P–N), 400 V (P–P), 500 V (P–P)
 Nominal frequency 50 Hz or 60 Hz
 Direct: Nominal current 5(65) A
 Transformer: Nominal current 1(6) A and 5(6) A

System

configuration: 2-wire alternating current, 3-wire or 4-wire three-phase alternating current

Measured

variables: Active energy and instantaneous power in standard variants; currents, voltages, active, reactive, apparent power, power factor, frequency optional

Display: LCD, 7-digit main display, 8-digit ancillary display

S0 output: Pulse output according to EN 62 053-31 or 230 V
 Pulse rate and pulse duration fixed or adjustable

Interface: Optional LON, M-bus or L-bus

Accuracy: Class 1 according to EN 61 036

Approval: Design approval D, A, CH, CZ, HR

Assembly: DIN rails according to EN 50 022

Stock variants

Article number	Description
U1281-V001	2-wire system, 230 V, 5(65) A, S0, pulse rate programmable
U1281-V002	2-wire system, 230 V, 5(65) A, S0, 1000 pulses/kWh, calibrated
U1289-V001	4-wire system, 3 x 230/400 V, 5(65) A, S0, 1000 pulses/kWh
U1289-V002	4-wire system, 3 x 230/400 V, S0, 5(65) A, 1000 pulses/kWh, calibrated
U1289-V003	4-wire system, 3 x 230/400 V, S0, 5(65) A, pulse rate programmable
U1381-V001	2-wire system, 230 V, 5//1 A, S0, CT/VT/pulse rate programmable
U1381-V002	2-wire system, 230 V, 5//1 A, S0, 1000 pulses/kWh, CT=VT=1, calibrated
U1387-V001	3-wire system, 3 x 100 V, 1 A, S0, CT/VT/pulse rate programmable
U1387-V002	3-wire system, 3 x 100 V, 5//1 A, S0 1000 pulses/kWh, CT=VT=1, calibrated
U1387-V003	3-wire system, 3 x 400 V, 5//1 A, S0, CT/VT/pulse rate programmable
U1387-V004	3-wire system, 3 x 400 V, 5//1 A, S0, 1000 pulses/kWh, CT=VT=1, calibrated
U1389-V001	4-wire system, 3 x 230/400 V, 5//1 A, S0, CT/VT/pulse rate programmable
U1389-V002	4-wire system, 3 x 230/400 V, 5//1 A, S0, 1000 pulses/kWh, CT=VT=1, calibrated
U1389-V003	4-wire system, 3 x 230/400 V, 5//1 A, S0, CT/VT pulse rate programmable, LON
U1389-V004	4-wire system, 3 x 230/400 V, 5//1 A, S0, CT=VT=1, LON, calibrated

Accessories

Battery pack for meter reading without continuously active power supply UBAT-24V

Installation set for door assembly U270A

Plug-on current transformers ASK 31.3, ASK 63.4, ASK 105.6, ASK 412.4

Winding current transformer WSK 30, WSK 40, WSK 70.6N

U389A



U389B



Electric energy meter with drum-type counter

Acquisition of active energy in 4-wire three-phase systems according to EN 61 036.

Customer benefit

- Precise active energy measurement according to EN 61 036, class 1
- Direct connection 5(65) A, without additional current transformers
- Transformer connection 5//1 A
- Can be read while electric circuit is switched off
- Error recognition for reverse-poled current direction
- Pulse output S0
- Compact design requires little space

Application

The energy meters may be universally used for the acquisition and internal billing of electrical energy in trade, household, industry and building management applications. The directly measuring U389A is designed for currents up to 65 A and saves costs for the installation of additional current transformers. The U389B variant for transformer connection takes both x/1 A and x/5 A current transformers. The connection to acquisition, billing and optimising systems, building automation and control engineering applications is achieved via the standard pulse output. Current transformers connected with reversed polarity and reversed direct connection are recognized and displayed as errors.

Technical data

Measurement

input: Nominal voltage 230/400 V (P-N/P-P),
nominal frequency 50 Hz,
Direct: Nominal current 5(65) A
Transformer: Nominal current 1(6) A and 5(6) A

System

configuration: 4-wire three-phase alternating current
Display: 7-digit drum-type counter
S0 output: Pulse output according to EN 62 053-31
Direct: 100 pulses/kWh
Transformer: 1000 pulses/kWh

Accuracy: Class 1 according to EN 61 036

Assembly: DIN rails according to EN 50 022

Stock variants

Article No.	Description
U389A	4-wire system, 3 x 230/400 V, 5(65) A, S0, 100 pulses/kWh
U389B	4-wire system, 3 x 230/400 V, 5//1 A, S0, 1000 pulses/kWh

Accessories

Installation set for door assembly U270A

Plug-on current transformers ASK 31.3, ASK 63.4, ASK 105.6, ASK 412.4

Winding current transformer WSK 30, WSK 40, WSK 70.6N

Gossen Metrawatt Energy Control System (ECS)

Overview

Energy Control System (ECS) – professional solution for industrial applications

The Energy Control System is the professional solution for industrial energy data acquisition and provides all of the basics required for consumption and load optimizing, as well as cost centre billing. The system meets the highest demands:

- Synchronization to the power utility's measuring interval
- Flexible grouping of meters according to type and installation density
- Autonomous evaluation and data storage at the summators
- Adaptable network topology and utilization of already installed cables
- High-speed data transmission suitable for large installations
- Web-oriented data read-out, analysis and billing software

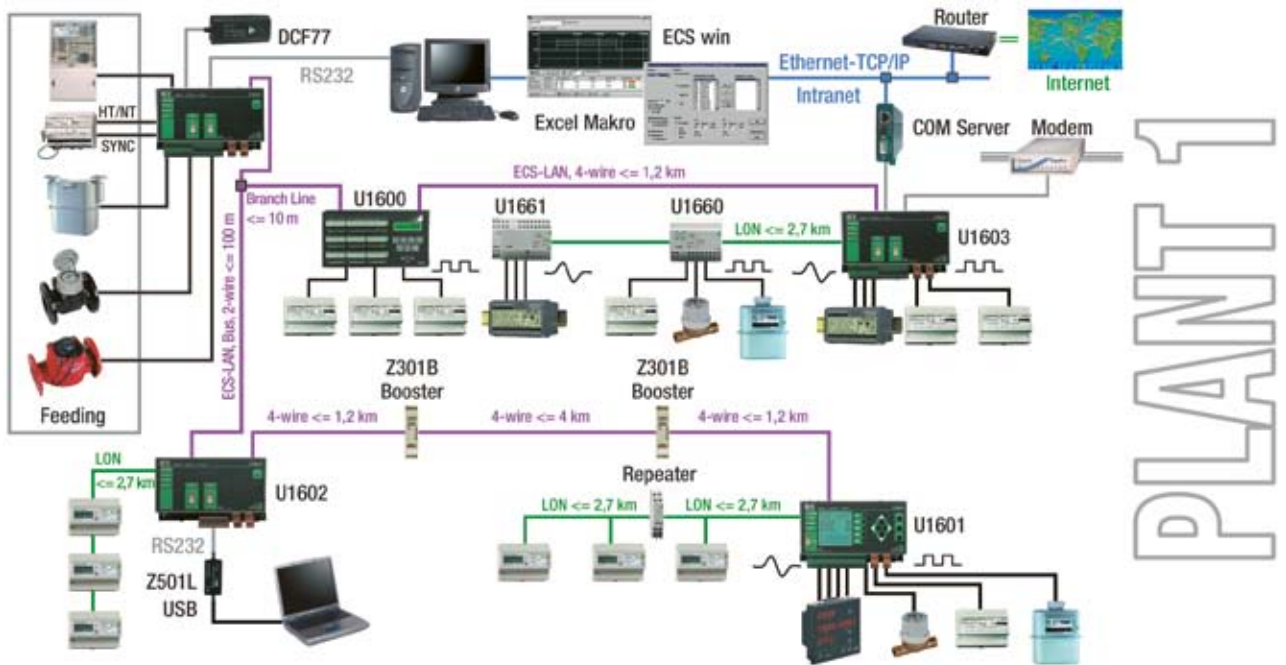

PLANT 1

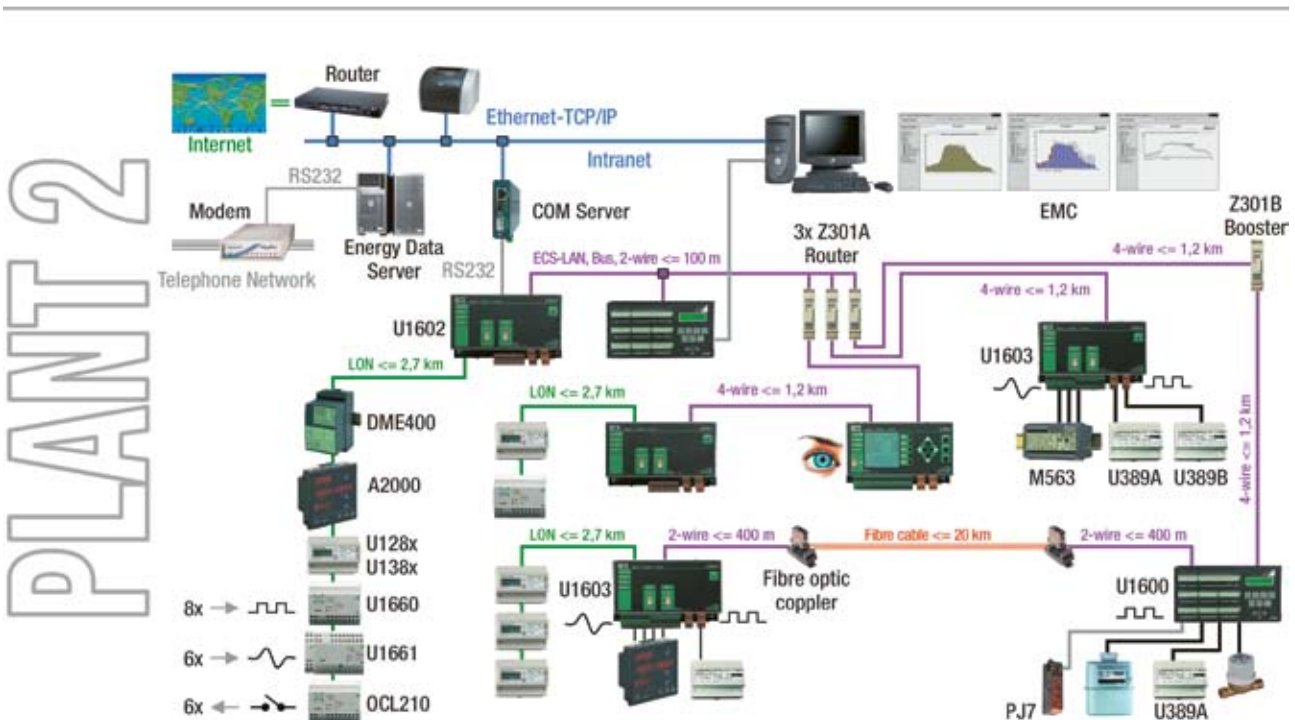

PLANT 2





Overview of summators

The summators of the Energy Control System acquire meter data via different interfaces and evaluate the same via internal calculation channels. The thus determined values for energy or consumption are summed synchronously to the measuring interval of the power utility over predefined time periods and a programmable interval, and are stored together with the respective maximum values. Using this autonomous energy database, all electrical and non-electrical energy and consumption values can be acquired, visualised, optimised and billed in relation to cost centres.

Individual summators can be interconnected over great distances via the multi-master compatible ECS LAN with a freely selectable network topology. All network users have unlimited access to any data in the network and make the same available at their serial RS232 interface. Analysing software packages have then access via the company network either directly or using an Ethernet TCP/ IP network adapter. Modems enable remote acquisition via public telephone networks.

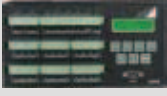
Due to its high level of integrated intelligence and the ECL custom programming language every summator is able to execute customised calculations, evaluations, monitoring and optimisation. External processes are controlled via user-specific background programs with partly available switching or analogue outputs.

The ECSwin software is used to parameterise summators and for simple data acquisition (see Page 62). The EMC software package (see Page 64) provides convenient functions for data read-out, analysis and billing.

	 <i>U1600</i>	 <i>U1601</i>	 <i>U1602</i>	 <i>U1603</i>
Display	LCD, 2 lines of 16 characters	LCD, 16 lines of 21 characters	–	–
Inputs	24	12	–	6
Input signals	S0 pulses	S0 pulses, analogue signals $\pm 10\text{ V}$, $\pm 20\text{ mA}$	–	S0 pulses, analogue signals $\pm 10\text{ V}$, $\pm 210\text{ mA}$
Outputs	4	8	–	8
Output signals	Relay contact (switch)	2 relay contacts 2 analogue outputs ($\pm 20\text{ mA}$) 4 MOS switches	–	2 relay contacts 2 analogue outputs ($\pm 20\text{ mA}$) 4 MOS switches
Calculation channels	32	64	64	64
LON bus	–	FTT-1078 k/Bit/s		
2x RS232	19200 Bit/s (split cable required)	115 kBit/s		

Gossen Metrawatt Summators

Summator – 24 pulse inputs

Customer benefit

- Autonomous acquisition, calculation and storage of energy and consumption data for up to 32 freely allocatable input channels
- Determination of load profiles with simple energy meters
- 24 puls inputs to connect energy meters
- Synchronisation to measuring interval of the utility via ECS-LAN
- Simple networking via ECS-LAN in 2/4-wire technology
- Local data processing via ECL programming language ECL
- Convenient display and programming on site

Application

The U1600 summator is designed for the direct connection of 24 energy and consumption meters with pulse output. It is particularly suited to the acquisition of a larger number of meters with pulse output installed in tight space conditions. Device settings and channel parameters may be directly changed and acquired values viewed on sight via the display and the operating elements.

Technical data

Inputs:	24 pulse inputs, S0
Outputs:	5 Relays, changer, 50 VDC/0.5 A 24 VDC power supply source, max. 0.4 A
Interfaces:	2 RS232, 19.2 kBit/s 2 ECS-LAN, RS485, 62.5 kBit/s, 2-/4-wire technology
Storage depth:	10 days for 32 channels @ 15 minutes interval Optional storage extension to 70 days
Display:	LCD, 2 lines of 16 characters, background lighting
Power supply:	80–250 VAC/DC, 19 VA Optional 20–80 VDC, 15 W
Dimensions:	240 mm x 125 mm x 80 mm
Assembly:	DIN rails according to EN 50 022

Stock variants

Article No.	Description
GTU1600000E0001	80–250 V AC/DC
GTU1600000E0002	20–80 V DC

Accessories

- For configuration software ECSwin see Page 62
- For load optimising module ECSopt see Page 63
- For EMC software „Energy management with system“ see Page 64
- For U1600 Excel-Macro see Page 63

U1600



U1601



Summator with 12 universal inputs and LON

Customer benefit

- Autonomous acquisition, calculation and storage of energy and consumption data for up to 64 freely allocatable input channels
- Determination of load profiles with simple energy meters
- 12 configurable inputs for analogue or digital signals
- Connection of up to 63 energy meters via LON
- Extendably inputs with external acquisition modules via LON
- Synchronisation to measuring interval of the utility via ECS-LAN
- Simple networking via ECS-LAN in 2/4-wire technology
- Local data processing via ECL programming language
- Convenient display and programming on site

Application

The U1601 summator is designed for the direct connection of 12 energy and consumption meters with analogue or pulse output. Every input can be set to the required signal via a DIP switch. The summator is particularly well suited to applications requiring a flexible input arrangement or convenient display and programming on site.

The LON interface permits the direct connection of electrical energy meters of the U128x (W1) and U138x (W1) series. A local or separated input extension for the summator can be arranged via the same interface. To this end, the U1660 meter acquisition module offers eight pulse inputs and the U1661 analogue acquisition module six analogue inputs.

Altogether 64 physical input channels are possible for the summator and may be freely allocated to the calculation channels.

Technical data

Inputs:	12 universal inputs, ± 5 mA, ± 20 mA, ± 10 V, 50 pulse adjustable
Outputs:	2 analogue outputs, ± 20 mA or ± 10 V adjustable 3 relays, changer, 250 VAC/8 A 4 MOS relay, switch, 50 VDC/0.2 A 24 VDC power supply source, max. 0.15 A
Interfaces:	LON, FTT-10A, 78 kBit/s 2 RS232, 115 kBit/s 2 ECS-LAN, RS485, 62.5 kBit/s, 2-/4-wire technology
Storage depth:	40 days for 64 channels @ 15 minute intervals
Display:	LCD 128x128 Pixel, 16 lines of 21 characters, background lighting
Power supply:	85–264 VAC / 100–280 VDC, < 15 W (25 VA) Optional 20–72 VDC, < 15 W
Dimensions:	212 mm x 125 mm x 85 mm
Assembly:	DIN rails according to EN 50 022

Accessories

- For configuration software ECSwin see Page 62
- For EMC software „Energy management with system“ see Page 64
- For U1600 Excel-Macro see Page 63

Gossen Metrawatt Summators

Micro-summator with LON

Customer benefit

- Autonomous acquisition, calculation and storage of energy and consumption data for up to 64 freely allocatable input channels
- Determination of load profiles with simple energy meters
- Connection of up to 63 energy meters via LON
- Separated inputs with external acquisition modules via LON
- Synchronisation to measuring interval of the utility via ECS-LAN
- Simple networking via ECS-LAN in 2/4-wire technology
- Local data processing via ECL programming language

Application

The U1602 micro-summator is designed for the direct connection of electrical energy meters of the U128x (W1), U138x (W1) and U168x series via the LON interface. Apart from the development of systems for purely electrical energy acquisition it is particularly well suited to the combination of energy and consumption meters placed in different areas.

For this purpose, a local or separated input extension can be arranged for the summator via the LON interface. The U1660 meter acquisition module offers eight pulse inputs for this and the U1661 analogue acquisition module six analogue inputs.

Altogether 64 physical input channels are possible for the summator and may be freely allocated to the calculation channels.

Technical data

Outputs:	1 relay, changer, 250 VAC/8 A 24 VDC power supply source, max. 0.15 A
Interfaces:	LON, FTT-10A, 78 kBit/s 2 RS232, 115 kBit/s 2 ECS-LAN, RS485, 62.5 kBit/s, 2-/4-wire technology
Storage depth:	40 days for 64 channels @ 15 minute intervals
Power supply:	85–264 VAC / 100–280 VDC, < 15 W (25 VA) Optional 20–72 VDC, < 15 W
Dimensions:	212 mm x 125 mm x 85 mm
Assembly:	DIN rails according to EN 50 022

Accessories

For configuration software ECSwin see Page 62

For EMC software „Energy management with system“ see Page 64

For U1600 Excel-Macro see Page 63

U1602



U1603



Mini-sumimator with 6 universal inputs and LON

Customer benefit

- Autonomous acquisition, calculation and storage of energy and consumption data for up to 64 freely allocatable input channels
- Determination of load profiles with simple energy meters
- 6 configurable inputs for analogue or digital signals
- Connection of up to 63 energy meters via LON
- Extendably inputs with external acquisition modules via LON
- Synchronisation to measuring interval of the utility via ECS-LAN
- Simple networking via ECS-LAN in 2-/4-wire technology
- Local data processing via ECL programming language

Application

The U1603 mini-sumimator is designed for the direct connection of 6 energy and consumption meters with analogue or pulse output. Every input can be set to the required signal via a DIP switch. The inputs and outputs make the mini-sumimator optimally suitable as a small acquisition and optimisation unit for different media at the supply point of the energy utility.

If main and subdistribution system are to be included in the acquisition system subsequently, the extension can be achieved via the LON interface with electric energy meters of the U128x (W1), U138x (W1) and U168x series. A local or separated input extension for the summator can also be arranged via the same interface. To this end, the U1660 meter acquisition module offers eight pulse inputs and the U1661 analogue acquisition module six analogue inputs.

Altogether 64 physical input channels are possible for the summator and may be freely allocated to the calculation channels.

Technical data

Inputs:	6 universal inputs, ± 5 mA, ± 20 mA, ± 10 V, SO pulse adjustable
Outputs:	2 analogue outputs, ± 20 mA or ± 10 V adjustable
	3 relays, changer, 250 VAC/8 A
	4 MOS relay, switch, 50 VDC/0.2 A
	24 VDC power supply source, max. 0.15 A
Interfaces:	LON, FTT-10A, 78 kBit/s
	2 RS232, 115 kBit/s
	2 ECS-LAN, RS485, 62.5 kBit/s, 2-/4-wire technology
Storage depth:	40 days for 64 channels @ 15 minute intervals
Power supply:	85–264 VAC / 100–280 VDC, < 15 W (25 VA)
	Optional 20–72 VDC, < 15 W
Dimensions:	212 mm x 125 mm x 85 mm
Assembly:	DIN rails according to EN 50 022

Accessories

For configuration software ECSwin see Page 62

For EMC software „Energy management with system“ see Page 64

For U1600 Excel-Macro see Page 63

Gossen Metrawatt Summators

Overview ECS with SMARTCONTROL

Energy Control System (ECS) with SMARTCONTROL – the professional solution for industry and building management applications

The energy control system with SMARTCONTROL is a professional solution for acquisition, visualisation, optimisation and billing. It records all energy and consumption data required for the development of an energy management system according to EN 16001. This provides all of the information required to

reduce consumption efficiently and to optimise loads of the most varied media. The intelligent SMARTCONTROL can issue alarms early on or even switch off individual loads in case of disturbances or when limit values are surpassed. The EMC application software, which is part of the system, gathers all of the information

from the SMARTCONTROLS in the different company fields, stores it in a central database and provides analyses via a website for Intranet or Internet access.

System architecture

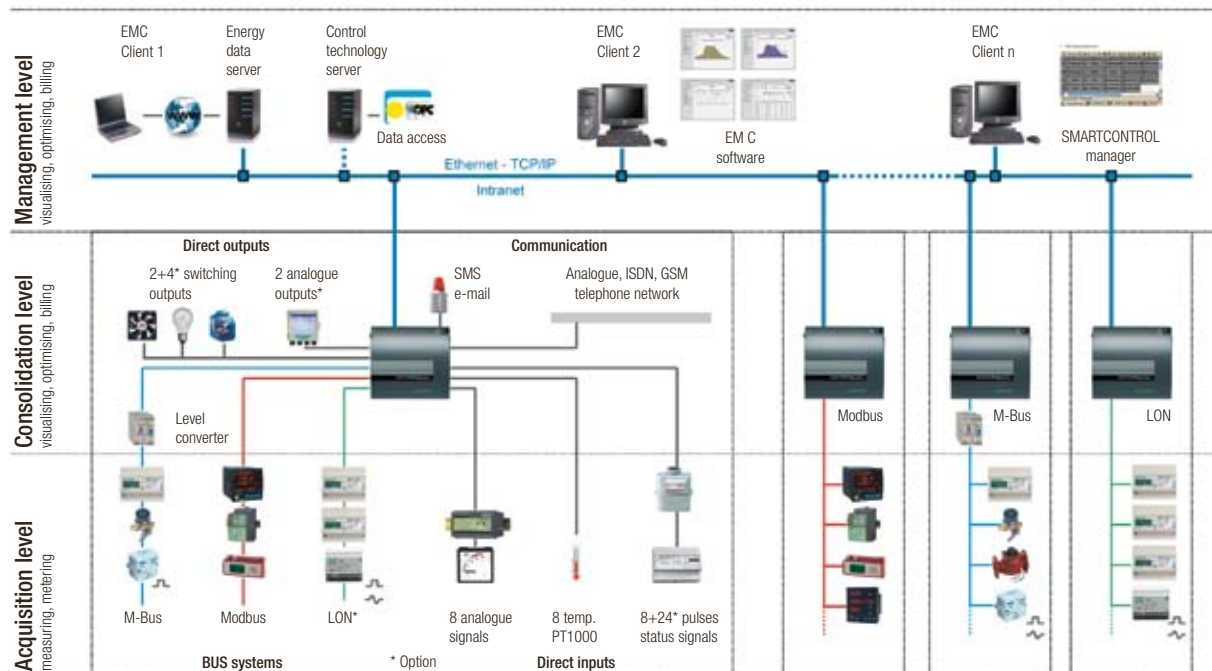

Application example

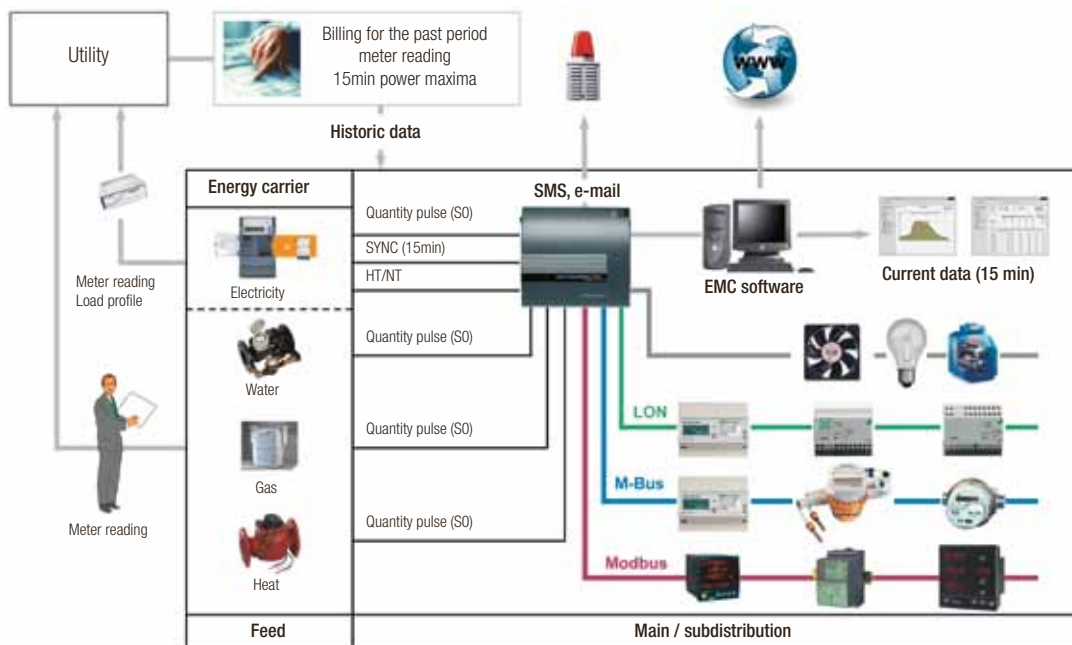

U200A



SMARTCONTROL ECS – Energy Control System

Customer benefit

- Acquisition of energy and consumption data, temperatures, switching statuses and process variables
- Error message management, continuous comparison of characteristic values and indication of errors via switching output, e-mail or SMS
- Peak load management in combination with switching outputs
- Timer programs and switching of relays after the occurrence of predefined events
- Calculation of mean values and integrals, as well as heat and cold quantities
- SMARTCONTROL manager configuration and data read-out software included in the scope of delivery

Application

The multitasking SMARTCONTROL supplements the Energy Control System (ECS) which is widespread in industry and building technology. It unites energy and consumption data logging for a wide variety of media with load management and error messaging functions. It can be used autonomously, or together with Energy Management Control (EMC) software within the ECS. Both solutions contribute to sustained conservation of valuable resources and reduced energy costs.

The versatile data collector can acquire directly meter readings, temperatures, statuses and analogue signals via existing inputs. The connection of bus-compatible instruments or energy meters is effected by Modbus via M-Bus with an optional level converter or via the optional LON interface.

The different parameters and functions of SMARTCONTROL are defined via SMARTCONTROL manager and its graphic programming surface. In particular, linking of the inputs with calculations, logic functions, time programs, relay, analogue, SMS and e-mail outputs is easily realised. The acquired channel data may also be read out, visualised in tables or diagrams and exported in csv or bmp format.

SMARTCONTROL is integrated into existing infrastructures via Ethernet TCP/IP. The talented communicator may also be equipped with an internal analogue modem, ISDN, GSM or Bluetooth module. An OPC server is available for an easy connection to process and building control systems.

The internal 2 MB flash ring buffer can be extended by the installation of a 2 GB Compact Flash memory card.

Technical data

- Inputs: 8 digital inputs, adjustable to active or passive
 8 analogue inputs 0 – 20 mA or 0 – 10 V, adjustable
 8 temperature inputs for Pt1000 sensors
 Option input/output module for 24 channels:
 24 digital inputs, active or passive setting possible
- Outputs: 2 semiconductor relays max. 40 VDC/AC, 1 A
 Option input/output module for 24 channels:
 4 semiconductor relays* max. 40V DC/AC, 1A
 2 analogue outputs* 0-20mA or 0-10V setting possible
 * May be configured individually instead of a digital input.
- Interfaces: Ethernet TCP/IP 10/100 Mbit, Modbus RTU, RS485,
 M-Bus via RS232 with optional level converter, 2 x RS232 for fieldbus devices
 Option LON interface module:
 LON, FTT-10A, 78kBit/s
- Memory: 2 MB flash, optional 2 GB compact flash
- Power supply: 12–24 VDC, ext. power supply plug 100–240 VAC/12 VDC, optional pluggable power pack, see accessories
- Dimensions: 225 x 210 x 70 mm

Gossen Metrawatt Summators

SMARTCONTROL ECS – Energy Control System

Stock variants

Article No.	Description
U200A	SMARTCONTROL standard
U200B	SMARTCONTROL control cabinet IP 65 with 12 VDC power pack
U200C	SMARTCONTROL control cabinet IP 65 with 24 VDC power pack
U200D	SMARTCONTROL standard with I/O24
U200E	SMARTCONTROL standard with LON
U200F	SMARTCONTROL standard with I/O24 and LON

Accessories

Pluggable power pack 100–240V AC / 24V DC / 24 W	Z301U
LON extension set **	Z301V
I/O24 input /output module for 24 channel extension set **	Z301W
Analogue modem socket module for analogue telephone network	Z301C
ISDN modem socket module for ISDN telephone network	Z301D
GSM/GPRS modem socket module for GSM telephone network	Z301E
Bluetooth socket module for radio communication	Z301F

** Requirement: SMARTCONTROL basic PCB starting Rev. 2.3x

For further accessories see data sheet and price list.



Gossen Metrawatt Additional Components for Summators

Z301A



ECS-LAN router

Star-type ECS-LAN topologies may be arranged with several routers which are connected via a 2-wire bus. The outputs have a 4-wire bus design with booster.

- Integrated router to optimise data transmission
- Suitable bus termination resistor
- Power supply 20–70 VDC

Z301B



ECS-LAN booster

The booster extends the ECS-LAN transmission distance to 4 km. A booster has to be installed at the beginning and end of the extended transmission range.

- Power supply: 20–70 VDC

U1660



Meter acquisition module for LON

The U1660 meter acquisition module extends the U1601, U1602 and U1603 summators by 8 external digital inputs via the LON interface. The module processes data from energy meters with pulse output (SO) or floating contact. The active inputs do not need any additional voltage supply thus minimising wiring expenditure.

Article No.	Description
U1660-V001	Meter acquisition module

U1661



Analogue input module for LON

The U1661 analogue input module extends the U1601, U1602 and U1603 summators by 6 analogue inputs via the LON interface. The module processes 4...20 mA standard signals or 0...20 mA standard signals in a modified variant.

Article No.	Description
U1661-V001	Analogue input module 4...20 mA

U1664



Bus termination for LON

The U1664 bus termination is employed in bus-type LON topology as 105 Ω termination at the end. At the beginning of the bus, the integrated 105 Ω bus termination of the summator is used. In free topology, the integrated 52.3 Ω bus termination is employed. This is analogously also applicable to the extended segment if a repeater is used.

Article No.	Description
U1664	Bus termination

Gossen Metrawatt Load Optimisation

Load optimisation

System to reduce power peaks, extendable in steps from 8 to 64 optimising channels.

Customer benefit

- Minimum interference in the production process due to the combined trend-extrapolation process
- Simultaneous optimising of different media
- Future-oriented setpoint management specifying the load profile for 7 days with 96 values each
- Inputs for operating feedback from the consumers
- Takes minimum and maximum making and breaking times of the power consumers into consideration
- Special control programs for kitchen optimisation

Application

Electrical power prices for customers with special contracts consist of energy costs (in EUR per kWh) for current consumption, and power costs for the maximum power value (in EUR per kW). A reduction of power peaks can reduce costs considerably.

Power optimisation assumes that the start-up of consumers which draw large amounts of power can frequently be postponed a few minutes without significantly affecting operations. This applies, in particular, to power consumers which are capable of storing energy to a certain extent, e.g. heaters and refrigerators. Integrated time switching programs can lower the energy costs and optimise operational procedures. The system can also be used for cost-oriented control of consumers which require other forms of energy, e.g. gas.

Technical data

Inputs: 16, individually switchable 24 VDC or 230 VAC, with potential-isolated in two groups
 Outputs: 9 Relays changer, 250 VAC max. 2 A, power supply 24 VDC, max. 100 mA
 Power supply: 230 V AC, 50 Hz, max. 15 VA
 Dimensions: 240 x 160 x 60 mm
 Assembly: DIN rails according to EN 50 022

Stock variants

Article No.	Description
U1500 A0	Optimising computer for 8 channels
U1500 A1	Optimising computer for 8 channels, extendable via system bus
U1500 A2	System extension for 8 channels

Accessories

For PC software configuration Z302C see Page 62
 For PC software online display Z302D see Page 62
 For PC software graphic data analysis Z302B see Page 62

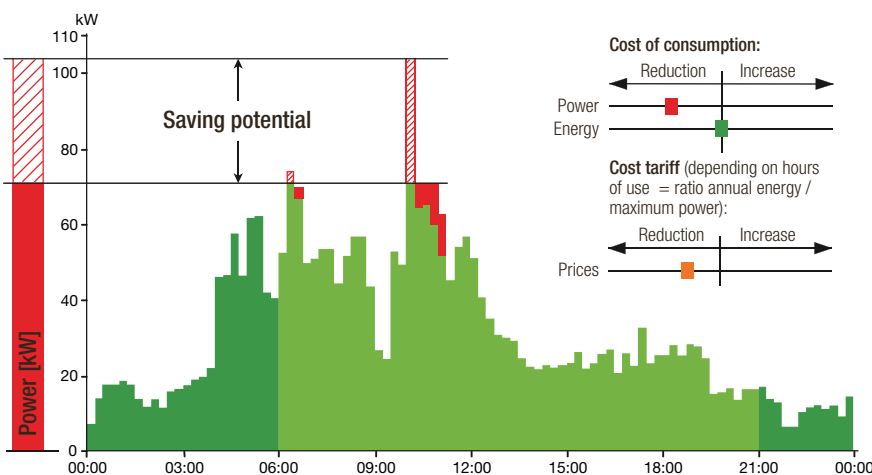

U1500

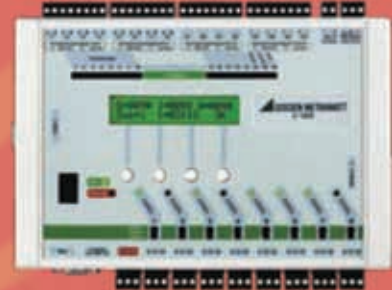

MAVOLOG 10 S



Power quality analyser

3-phase system analyser for voltage quality according to EN 50 160.

Customer benefit

- Monitoring and evidence of voltage according to EN 50 160
- Transparency in energy and power values
- Monitoring of power factor and reactive power compensation

Application

The analyser is designed for all areas of application, from the producer (utility) down to the energy consumer and may be used both individually and together with other devices. The professional model, MAVOLOG 10S, has voltage measuring inputs and acquires dips, interruptions and swells in excess of 10 ms, asymmetry, frequency, harmonics up to the 40th order as well as THD and flicker.

The device has current measuring inputs in addition and can thus be used as a universal power measurement device. It registers the progression of almost all measured variables in three-phase systems, acquires system disturbances and analyses the voltage quality according to EN 50 160.

Technical data

Meas. input: 4x nominal voltage 100/400 VAC (L-L), nominal frequency 50/60 Hz
3x nominal current 1/5 A

System

configuration: 3-/4-wire three-phase alternating current
Display: Alphanumeric LCD, 1-line, 60 x 10 mm
Output: Relay contact, 50 V, 0.5 A
Interface: Bidirectional RS485 2-wire bus, 9.6...115 kBit/s, max. 32 participants
Power supply: 16–36 VDC, max. 3 W
Dimensions: 100 x 75 x 105 mm
Assembly: DIN rails according to EN 50 022

Stock variants

Article No.	Description
M830R	MAVOLOG 10S

Accessories

<i>MAVOLOG PS/C</i> Power pack 230 V / 24 VDC and interface converter RS485/RS232	Z863D
<i>MAVOLOG PS/C universal</i> Wide-range power pack 60 – 320 VDC, 50 – 230 VAC / 24 VDC and interface converter RS485/RS232	Z863G
<i>MAVOLOG BP</i> DC emergency back-up for MAVOLOG 10 in case of system failure	Z863E
<i>METRAWIN 10 / MAVOLOG</i> Parameterising and visualising software	Z852D
<i>PC.doc-ACCESS / MAVOLOG</i> Database software to prepare tables and diagrams with MS-Office products ACCESS, EXCEL, WORD	Z852F

Gossen Metrawatt Power Quality

System failure analysers

Monitoring system for the analysis of system quality, power and energy.

Customer benefit

- Combination with up to four virtual analysers in one housing
- Input modules for 4x voltage, 4x current, 8x digital signal
- Local operating and visualising via the optional ¼ VGA touchscreen
- Certification according to IEC 61 000-4-30, Class A
- Time synchronisation via the NTP time server and/or optional GPS receiver
- Cross triggering internal and external
- Conformity with all national and international standards
- Ethernet 10/100 BaseT, RS232, RS485 interfaces as a standard
- Communication protocols TCP/IP, HTTP, XML, Modbus TCP/RTU

Application

As soon as an indication of poor system quality occurs, effective action is required. Typical indications include overheated motors, transformers, lines, excessive currents in neutral conductors, flickering lights, computers or inexplicable rises in energy costs. Using MAVOSYS 10, disturbances and events can be easily localised, documented and analysed with respect to standards, also within the most complex systems – the perfect basis for sustained optimisation. This increases operational safety, keeps up the product quality and ensures a high degree of cost efficiency.

Pathbreaking innovation

MAVOSYS 10 constitutes a real breakthrough in technology:

It is the first system analyser to surpass the classic maximum limit of 8 channels for voltage and current inputs. Users may now choose between input modules for voltages (4 channels), currents (4 channels) and digital signals (8 channels). Applications previously requiring two or more devices may now be realised by a combination of up to 4 modules in one MAVOSYS 10. This saves space and reduces costs.

Common combinations are:

- 8 channels for traditional monitoring of the system quality and power:
one input module each for voltage and current
- 16 channels for function monitoring of plants, such as uninterrupted power supply (input/output):
two input modules each for voltage and current
- 16 channels to monitor the supply of substations:
One input module for voltage and three for current.



Voltage conformity



Subdistribution



Standard power quality



UPS monitoring

 4 channel voltage module

 4 channel current module

Preconfigured complete systems (no changes possible)

Type	Description	Article No.
61STD-PQ	Basic unit 61STD, 4 slots, 1x 61MVS, 1x 61MAS5	M818A
61SG-PQ	Basic unit 61SG, 4 slots, 1x 61MVS, 1x 61MAS5	M818B
61SGD-PQ	Basic unit 61SGD, 4 slots, 1x 61MVS, 1x 61MAS5	M818C
61VCM	Monitor for voltage monitoring, 1 slot, 1x 61MVS	M818D

MAVOSYS 10

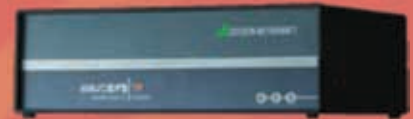

Content Software, Accessories

Software for heavy current transducers and power meters

Configuration software	60
CB-Manager	61
CB-Analyzer	61
Profibus mini-CD	61

Software for energy management

Z302B, Z302C, Z302D.....	62
ECSwin, configuration software for U160x	62
ECSopt, module load optimising for ECSwin.....	63
U1600 Excel-Makro	63
EMC, energy data management with system.....	64
Encore Series	65

Accessories for heavy current transducers and power meters

Programming and additional cables	66
---	----

Basics

Electromagnetic compatibility	67
Environmental testing.....	69

Camille Bauer

Software for Heavy Current Transducers and Power Meters

Configuration software

To parameterise programmable CB devices.

All software products of Camille Bauer can be used ONLINE (connected to the device) and OFFLINE (without a connected device). In this way, parameterising and the documentation for all devices to be used can be performed and stored prior to commissioning. The CD contains the following PC software:

DME4

- Programming of all features of the respective device variants
- Measured value display of analogue/digital output values as well as all variables which can be acquired
- Simulation of outputs to test subsequent circuits
- Printing of configuration and nameplates
- Resetting of slave pointers
- Setting / resetting of meter readings
- Password protection for selectable functions

M560

- Programming of all features of the respective device variants
- Visualising of measured values with recorder representation, storage possibility and subsequent analysis mode, measured value file can also be exported to Excel
- Simulation of analogue outputs to test subsequent circuits
- Printing of configuration files and nameplates
- Resetting of slave pointers
- Graphic representation of the linearisation characteristic of each output
- Password protection for selectable functions

A200plus, A200plus handheld

- Acquisition and change of all device features
- Measured value display of all acquired variables
- Acquisition / setting / resetting of meters and minimum / maximum values
- Acquisition and visualising of mean values stored in the logger
- Direct export of logger data to Microsoft Excel

The CD contains further PC software for angular position and process control engineering.

Content of the CD

Software	For devices	Language	Operating system
VC600	SINEAX/EURAX V604, VC603, SIRAX V644	D, E, F, N	9x, NT4.x, 2000, ME, XP Vista, 7 (32-Bit) Vista, 7 (64-Bit)
V600plus	SINEAX VK616, VK626, V608, V624, V611, SIRAX V606	D, E, F, N, I, S	
TV800plus	SINEAX TV809	D, E, F, N	
DME 4	SINEAX/EURAX DME4xx	D, E, F, N, I	
M560	SINEAX M561, M562, M563	D, N, F, N, S	
2W2	KINAX 2W2, WT711, WT717 and SR719	D, E, F, N	
A200plus	SINEAX A210, A220, A230, A230s with EMMOD201 or EMMOD203	D, E, F, N	
A200plus handheld	A210-HH, A230-HH	D, E, F, N	

Article No.	Description
146 557	Configuration software (CD)



Camille Bauer Software for Heavy Current Transducers and Power Meters



CB-Manager

For the universal measuring unit for heavy-current variables SINEAX CAM and *APLUS*.

This software permits ONLINE/OFFLINE parameterising of SINEAX CAM and *APLUS* as well as visualising measured values. It also supports users in commissioning and service. The program design is system-oriented and thus enables the simultaneous communication with several devices.

- Acquisition and change of all device features
- Setting of real-time clock and time zone, selection of the time synchronisation method
- Archiving of configuration and measured value files
- Visualising of instantaneous values
- Acquisition, setting and resetting of meters and minimum / maximum values
- Starting, stopping and resetting of the optional logger
- Recording of measured value progression during commissioning
- Check of correct device connection
- Simulation of outputs to test subsequent circuits
- User and access setting for the protective password system

The software may also be used for the modular control system SINEAX VR660 / A200R and the multifunctional transducer SINEAX V604s.

Article No.	Description
156 027	Doku-CD, incl. configuration software CB-Manager

This CD is part of the scope of delivery of SINEAX CAM, *APLUS*, SINEAX VR660 and V604s.



CB-Analyzer

For the universal heavy-current measuring units SINEAX CAM and *APLUS*.

The .NET-based software facilitates the data acquisition and analysis of the optional data loggers and lists of SINEAX CAM and *APLUS*. The data will be stored in a database so that a much longer history is built up than would be the case if only the present memory content of the device was analysed. The program is capable of processing several devices simultaneously.

- Acquisition of logger and list data of several devices
- Storage of the data in a database (Access, SQLClient)
- Report generation in list or graphic format
- Selectable time range in the preparation of reports
- Export of report data to Excel or as an Acrobat PDF file
- Different analysing options of the acquired data, also across devices

Article No.	Description
156 027	Doku-CD, incl. analysis software CB Analyzer

This CD is part of the scope of delivery of SINEAX CAM, *APLUS*, SINEAX VR660 and V604s.

Profibus Mini-CD

For the DME406 multi-transducer and the EMMOD204 extension module.

The CD contains the respective GSD file and the operating instructions as well as a commissioning guideline and further Profibus documents.

Article No.	Description
150 764	Profibus mini-CD

This CD is part of the scope of delivery of SINEAX DME406.



Gossen Metrawatt Software for Energy Management

PC software for load optimising

The listed software packages are not required for the basic function of the U1500 optimising system but they offer useful additional functions for energy consultants and interested users. All packages work under Windows 95, 98, ME, NT, 2000, XP and contain the basic modules of data transfer, configuration signals and channel monitor.

Load optimising configuration module Z302C

All of the configurations and settings required for the device can be conveniently entered at the PC, stored to memory, displayed, printed out and transmitted to the optimising computer.

Recommended for those who frequently start up optimizing systems, or have to adapt existing configurations.

Online display module Z302D

Data for the current measuring period and the current switching statuses of interconnected operating equipment can be displayed online with this software.

Recommended for those who always want to have a good overview of their optimising system during any given measuring period.

Graphic data analysis module Z302B

This module allows for graphic analysis of all archived data such as load characteristics and switching operations. Recurrent data analysis is executed after the graphic configuration has been selected and stored to memory once only.

Recommended for those who want to document savings generated by the system, as well as analyze and optimise the switching operations required to this end.

Z302B / Z302C / Z302D

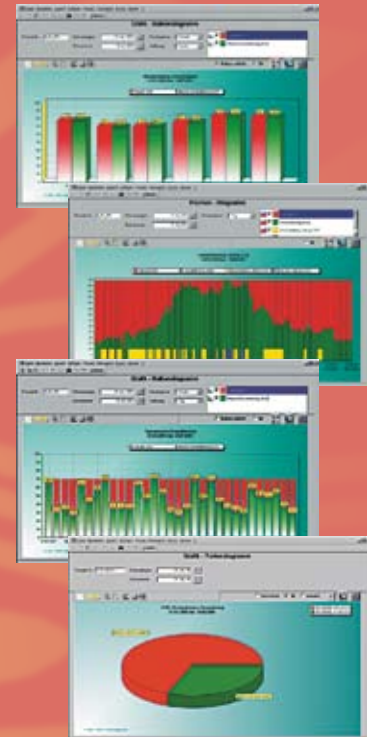

Configuration software for U160x summators

Configuration of the U160x summator, manual read-out of stored energy data and simple visualising.

Customer benefit

- Convenient configuration of U160x summators
- Easy programming of virtual channels
- Direct command entry via terminal function
- Graphic representation of control panel for remote control
- Graphic representation of ECS-LAN network topology
- Acquisition and visualising of stored data
- Recorder representation for instantaneous values
- Optional: Simple load optimising for U1600 with ECSopt

Application

ECSwin software configures U1600, U1601, U1602 and U1603 summators easily and conveniently. Parameter settings are read out from the summators, and are displayed in data entry windows. All values may be changed, saved to memory and transferred to the summators. The software can access the summators via RS232 interface, modem, Ethernet TCP/IP and COM-Server.

Technical data

Operating system: MS Windows 95, 98, NT4, ME, 2000, XP, Vista

ECSwin



Article No.	Description
Z302E	ECSwin

ECSopt

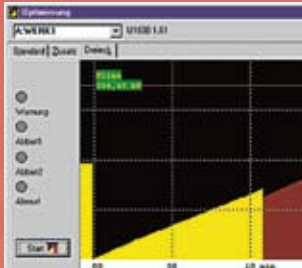

Load optimising module for ECSwin

4-channel load optimising for U1600 summators.

Customer benefit

- Savings in energy costs by the reduction of peak loads
- Specification or measurement of loads which can be shut down
- Consideration of limit values depending on tariff periods
- Adjustable rotation of loads to be shut down
- Consideration of reaction times of loads
- Protocol of switching operations

Application

Peak loads are reduced by the control of max. 4 consumers in combination with ECSwin and a U1600 summator. In addition, the 4 switching outputs and the background programming of the U1600 summator are used. Parameters may be conveniently set via ECSwin.

Article No.	Description
Z302F	ECSopt

U1600 Excel-Makro



Macros for MS Excel

For data upload from U16xx summators.

Customer benefit

- Availability of energy data in MS Excel
- Preparation of analyses and reports

Application

Using the U1600.XLM macro, energy data from the U160x summators can be directly exported to Microsoft Excel spreadsheets, Version 4.x or higher, and made available for customer-specific evaluation. Connection of the PC to the summator is configured in Excel, and is established directly via the RS232 interface, modem, Ethernet TCP/IP and COM-Server.

Article No.	Description
Z302G	U1600 Excel-Makro

Gossen Metrawatt Software for Energy Management

Energy data management with system

Application software to acquire, visualise and bill energy data from the Energy Control System (ECS).

Customer benefit

- *Remote read-out of meter data* provides time-synchronised data, saves long-distance travel and avoids reading and input errors. Brief read-out intervals result in load profiles which serve as a basis for optimising and billing
- *Diagrams* create comprehensive transparency in consumption and load structures. They reveal weak points and constitute the basis for consumption, process and maximum optimisation.
- *Reports* document the consumption and determine costs on basis of the allocated tariffs. They form the basis for responsible handling of energy, internal billing and contract negotiations with utility companies.
- *Billing* is in relation to the tenant in let objects and to the cost centre in industrial operations. The required administrative functions are integrated.
- *Planned data* the schedule in energy supply contracts. Deviations in relation to the real load curve are visualised and constitute the basis for schedule optimising.
- *Virtual channels* calculate new data for all analyses. Different loads can be combined, distributed or determined via balancing circles. Benchmarking is facilitated by the calculation of key figures.

Application

Working in combination with the high-performance Energy Control System the user-friendly EMC (Energy Management Control) software is designed in an optimum fashion for applications in industry, energy and building management. Energy data of all media may be read remotely, stored, visualised, analysed and billed. Browser-oriented operation via tree structures and integrated help functions safeguard intuitive operation with brief familiarisation periods. Several users can access simultaneously the data archived in a high-performance SQL database via Intranet or Internet. A user management system controls specific access rights. The software is of a modular design and can be adjusted to individual requirements.

Technical data

Computer: min. Pentium PC, 1 GHz, 250 MB RAM
 Browser: Internet Explorer starting Version 6.0 SP 1
 Operating system: MS Windows 2000 SP 4, XP
 Languages: D, GB, F, I, NL, CZ, PL switchable

Article No.	Description
Z308A	EMC Basic version
Z308B	EMC Expansion – Providers and Tariffs
Z308C	EMC Expansion – Building Automation / Industrial Version
Z308D	EMC Expansion – Consortium
Z308E	EMC Expansion – Virtual Channels
Z308F	EMC License – 5 User
Z308G	EMC License – 5 Locations / Energy Types
Z308H	EMC License – 100 Measuring Points
Z308I	EMC License – 5 Companies
Z308J	EMC Full Version

EMC

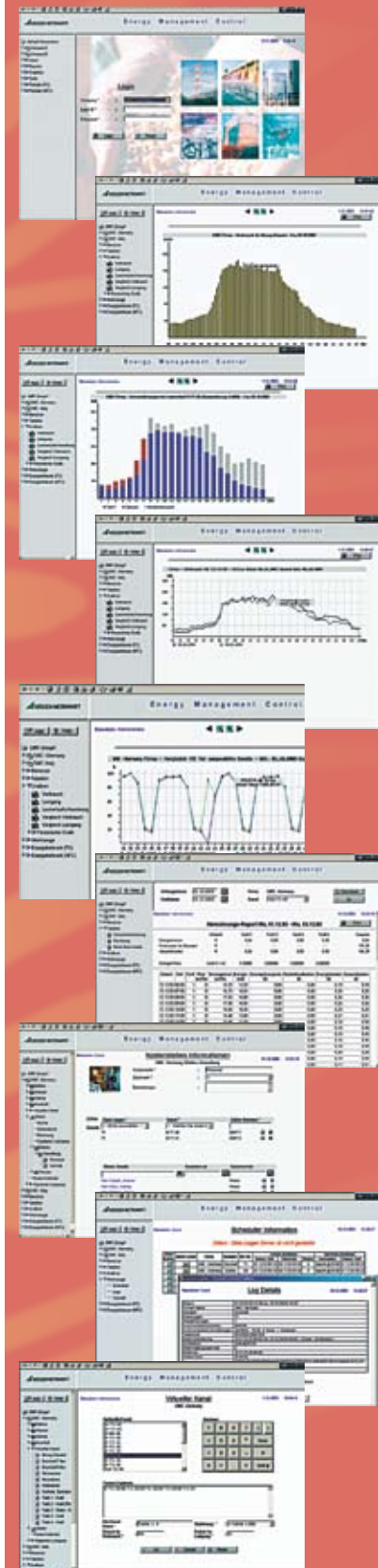

Encore Series

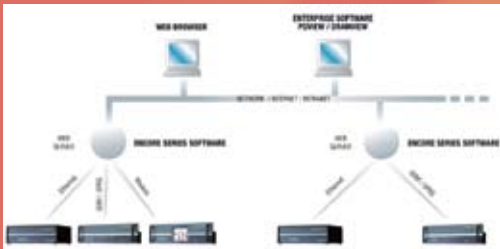

Analysis and Evaluation Software for MAVOSYS 10

User-friendly Encore series software is available for controlling and communicating with the MAVOSYS 10. It allows for visualization and analysis of events, sequences and measured values.

Automatic evaluations can be executed with optional AnswerModules® – intelligent algorithms for specific data interpretation.

Mains Management Simplified

With Encore series software, the MAVOSYS 10 can be utilized ideally in a great variety of electrical systems with a large spectrum of configurations. The software's special strengths include a password protected multiuser web interface and a broad range of functions: Even complex monitoring and analysis tasks can be organized and processed in a clear-cut fashion. Encore series software is thus ideally suited for convenient data acquisition and storage.

- Simple user interface based on a web browser
- Up to 50 or more MAVOSYS 10 instruments are supported
- Mains quality, demand, energy and process analyses

Enterprise software is additionally available for extended analyses and management of several logging systems.

Intelligent Analysis Extras

Decades of experience and expert knowledge have been engineered into our AnswerModules® – intelligent algorithms for automatic interpretation and compilation of data. They're integrated into Encore series software as required, and they expand its range of functions.

Available AnswerModules®

- **Sag Direction:** diagnosis of voltage sags and the direction to their cause
- **CapSwitch™:** analysis of transients triggered by switching compensation capacitors
- **kVAR Verification:** monitoring of compensation systems for correct functioning
- **UPS Verification:** monitoring of uninterruptible power supplies for correct functioning
- **Energy User:** specific reports regarding energy consumption and costs
- **Radial Line Fault:** *ascertainment of cause and distance to faults in the mains*
- **Reliability Benchmark:** ascertainment and evaluation of mains reliability
- **Online-Diagram:** customer-specific system diagrams with indication of current states, events and mains quantities

Type	Description system software	Article No.
Encore Series Software	Encore series server software for the Mavosys range, customer PC requirements: 8 GB hard disk, web server, HASP key	Z820A
DVE-PQDIF	DranView Enterprise version for reading PQDIF, COMTRADE and text files (USB HASP version)	Z820B
NodeLink	Enterprise software, saves data in PQDIF format, for use with PQView and DranView	Z820C

Type	Description answerModule® (for Encore series software)	Article No.
SW PFCAP	AnswerModule – compensation capacitor directional characteristic	Z820D
SW VAR	VAR test instrument for SW PFCAP AnswerModule	Z820E
SW SAG	AnswerModule – voltage sag directional characteristic (SAG)	Z820F
SW UPS	AnswerModule – USP function test	Z820G
SW RADL	AnswerModule – star line fault	Z820H
SW EUAM	AnswerModule – energy consumption	Z820I
SW RBM	AnswerModule – reliability test	Z820K
SW ADAM	Driver module – Advantech ADAM	Z820L

Programming and additional cables

serve programming of the instruments in connection with the respective configuration software and using a PC.

Customer benefit

- Programming operation without any additional power supply connection
- Communication with the instruments
- Safe galvanic isolation of instrument and PC
- Cost-effective instruments (M56x) due to separated programming interface

Article No.	Description	A2xx * A2000	A200 to DME4xx	DME4xx	M56x	EDS- CAM
147 779	Programming cable PRKAB 560 (NEx)				•	
143 587	Additional cable				•	
152 603	Interface adapter cable	•				
154 071	Connecting cable Sub-D 9 pol. male/male		•			
980 179	Extension cable Sub-D 9 pol. male/female	•		•		
168 949	Connecting cable 2 m EDS-CAM <-> SINEAX CAM					•

* A210, A230s, A230 with plugged-on EMMOD201



147 779



143 587



152 603



154 071

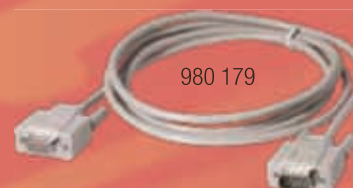

980 179



168 949

Electromagnetic compatibility

What is it all about?

Electromagnetic compatibility (EMC) signifies that electrical and electronic products work safely at their place of use. To safeguard this, the interfering emission of electromagnetic signals of devices, systems or plants must be limited. On the other hand, it must also be safeguarded that devices, systems or plants are not impaired by the interfering signals present in their environment. These relatively simple facts are stipulated in the EMC Directive 89/336/EC and can only be achieved if all those involved play the game. All manufacturers are obliged to test their products accordingly or have them tested.

The CE-mark is the basic precondition that a product may be put into circulation in Europe. In this way, manufacturers confirm that their products conform to applicable directives for their type of product. The EMC directive is an integral part of this requirement profile. Outside of Europe, other identification obligations are partly applicable. These are now harmonised to such an extent that also in relation to EMC comparable requirements can be assumed.

The problem

The increase of electrical and electronic products in the industrial environment but also in products of daily use is still immense. More and more functionality with even higher performance is implemented in these products. Processor systems with increasingly higher clock frequencies are being used. They generate higher and higher

levels of interference unintentionally and also become more and more sensitive to interfering sources in their environment.

To make matter worse, the applications using radio frequencies are also increasing. For example, mobile telephones must be in a position of sending and receiving signals. Though their transmission output is limited, incompatibilities might result if they are used inconsiderately in the vicinity of sensitive devices. Systems may be interfered with to such an extent that they provide wrong signals or break down completely. This is the reason, why their use is often limited, e.g. in aircrafts or also in hospitals where sensitive medical devices might be affected. The awareness of EMC problems in aircrafts has been established over years but must still be pointed out to passengers prior to every take-off. When entering a hospital hardly anybody turns of his or her mobile telephone despite warning messages on the walls. Operational managers of power plants are often not aware of the fact that the use of mobile telephones in the vicinity of measuring, controlling and regulating units can be critical. Radio and television stations, mobile radio antennae or remote controls also work with frequencies which might interfere with sensitive devices and impair their operation.

Sources of interference

In the industrial environment, frequency converters, motors and other consumers are increasingly operated parallel to sensitive measuring and control systems. Higher levels of interference must generally be expected in all

places where high power is applied, switched or pulsed or electronic systems with high pulse frequencies are used.

The use of wireless telecommunication facilities or networks also increases the probability of incompatible levels of interference in the environment of sensitive equipment.

Standards

Applicable specific basic standards define the requirements of products and systems for use in their original environment. A limited number of tests with evaluation criteria and the expected operating behaviour are determined using defined measuring and test procedures. Specific basic standards contain details of the measuring method and general conditions. Specific EMC standards are available for certain products or product groups and have priority over the general requirements mentioned above.

EMC safety can only be achieved by a complete examination in accordance with standards. Since all standards are interrelated only their sum total provides a satisfactory result. Partial examination is not permitted, however still done by some manufacturers due to lacking measuring equipment or for reasons of costs.

Meeting standards does not necessarily provide smooth operation. A device may be subjected to higher loads in operation than envisaged by the standard. This might be caused by insufficient protection of the equipment or by EMC-incompatible wiring. In such a case, the behaviour of the device is largely undefined since it has not been tested.

Tests at Camille Bauer

Camille Bauer has its own EMC laboratory where the complete scope of all required tests (see below) can be performed. Even if our laboratory is not accredited, comparative measurements at the premises of respective service providers as well as subsequent checks by customers confirmed our test results in each case.

We also test our devices under higher loads than demanded by the standard even if this is not explicitly stated in our data sheets.

Specific basic standards

IEC / EN 61 000-6-2

Immunity standard for industrial environments

IEC / EN 61 000-6-4

Emission standard for industrial environments



Measurement of the behaviour of the devices in voltage dips, brief interruptions or voltage fluctuations of the power supply

Electromagnetic compatibility

Basic standards

IEC / EN 61 000-4-2

Immunity to static discharge which occurs as potential differences - mainly caused by friction electricity - are reduced. The most known effect is surely when persons get charged as they walk across a carpet and discharged with the generation of a spark when they touch a metal part. If this is, e.g., the plug of an electronic device the brief current impulse might be sufficient to destroy the device.

IEC / EN 61 000-4-3

Immunity to high-frequency electromagnetic fields. Typical sources of interference are radiotelephones used by the operating, maintenance or service staff, mobile telephones and transmitting facilities needing these fields. Coupling happens via the air. Unintentional fields also occur in welding facilities, thyristor-controlled inverters or fluorescent lamps.

Coupling might as well be generated via the line in such cases.

IEC / EN 61 000-4-4

Immunity to fast transient interference variables (bursts) which are generated in switching operations (interruption of inductive loads or bouncing of relay contacts)..

IEC / EN 61 000-4-5

Immunity to impulse voltages (surges) which are generated in switching operations or lightning and arrive at the device via the connecting lines.

IEC / EN 61 000-4-6

Immunity to conducted disturbances, induced by high-frequency fields which are typically generated by radio transmission facilities. Coupling takes place via the connecting line of the device. For further sources of interference see 61000-4-3.

IEC / EN 61 000-4-8

Immunity to magnetic fields with power frequencies. Strong magnetic fields result, e.g., in the immediate vicinity of power lines or bus bars.

IEC / EN 61 000-4-11

Immunity to voltage dips, brief interruptions and voltage fluctuations. Dips and brief interruptions of the supply voltage result from errors in the supply system or when large loads are switched. Voltage fluctuations are caused by fast-changing loads, e.g. in arc furnaces, and also generate flickering.



Determination of device behaviour under the influence of a magnetic external field generated by a Helmholtz coil

Environmental testing

What is it all about?

Products are exposed to many environmental impacts during their useful life. These are not limited to impacts during operation in the intended application in the field but also comprise detrimental influences during storage or transport to customers. The impacts include temperature, climate, water and dust conditions but also mechanical stress like vibration or shock.

The tests have the objective of checking the resistance against possible environmental impacts and to ensure reliability in later operation. Assumptions are made, e.g. concerning the reference range for environmental temperature or the annual average relative humidity. Users must compare these details with their own requirements (see data sheet). It is only after this check that they can be certain that the device suits their applications and will show the desired behaviour.

Standards

The requirement of testing the behaviour of devices in changing environmental conditions is derived from product group standards for Camille Bauer products, e.g. EN / IEC 60 688 „Electrical measuring transducers for converting a.c. electrical quantities to analogue or digital signals“. The normal place and type of use and the prevailing environmental conditions to which these instruments are exposed are known. Tests and test criteria which the device has to meet are derived from this information. For firmly installed instruments these tests concern the operational behaviours in changing temperatures (cold, dry and humid heat) as well as the influence of vibration and shocks.

Operation

The ambient temperature in which a device is operated can change quickly, e.g. if a part of the plant in which the device has been installed heats up due to operational demands or because of the difference of day and night temperatures in rooms which are not heated. Usually, devices heat themselves up. This can occur due to dissipated heat of passive components or self-heating of processors. Depending on the season and the environment, the heat may be dry or humid, i.e. precipitating or not precipitating. Thermic testing might take hours or days. The device is operated under normal conditions, i.e. with

input signals and loaded outputs. The ambient temperature is changed step by step in regular intervals, kept constant and then changed again, either positively or negatively. In this way, the entire operating temperature range of the device is applied upwards and downwards. Any change in the behaviour of the device and the extent of the same is verified after each step. On the one hand, the test shows whether the instrument meets the accuracy requirements within the reference range and, on the other hand, the temperature influence outside of the reference range is checked.

If the devices are installed in the vicinity of rotating machines, assembled in ships or transported to customers by lorries and aeroplanes, they are exposed to permanent vibration. This might lead to larger components being cut off or mechanical locking devices of the housings being opened. Vibration testing in which the tested object is exposed to repeated harmonic vibration helps to find weak points and to eliminate them. Shock testing, on the other hand, subjects the device to a specified form of shock through acceleration and breaking at irregular intervals. In this way, the behaviour of the device can be tested if it is dropped from a certain level.

Special measurements

Not all instruments are used in applications covered by standard tests. Earthquake vibration tests, for example, require low-frequency vibration of a high amplitude. Our test facilities cannot process the required test schedule exactly. Therefore, the measurements have to be done externally. Normally, customers assume the costs for this service. Upon request, we will be pleased to make test instruments available if you intend to perform the tests yourself.

Standard tests can also be performed with changed general conditions. Whether and to what extent customers participate in the costs incurred will be decided in each case.

Tests at Camille Bauer

Camille Bauer has test facilities to perform all required product tests in-house.

Overview of tests

EN / IEC 60 068-2-1 – cold
EN / IEC 60 068-2-2 – dry heat
EN / IEC 60 068-2-78 – humid heat
EN / IEC 60 068-2-6 – vibration
EN / IEC 60 068-2-27 – shock

Camille Bauer

Products for angular position engineering

Angular position transducers

The angular position transmitters from Camille Bauer are precision instruments and serves the acquisition of angular position and rotation, processing and the provision of measured values as electric output signals for the downstream device. They convert the angular position of a shaft into a load-independent direct current signal, proportional to the angular position.

The robust design makes the angular position transmitters of the KINAX WT7xx series particularly suited to applications in rough environments. The products are used in many areas, preferably in large machine construction, industrial plants, power plant construction, ship and offshore facilities, crane vehicles, large transport vehicles, dredger and drilling equipment.

The compact design of the KINAX to be installed or for surface mounting makes the angular position transmitters particularly suited to the installation in or mounting on devices and apparatuses. The products are used in many applications, e.g. railway engineering, industrial plants, ship building, power plant construction and gate positions.

Main features

- Simple connection technology with 2, 3, 4 wire or plug connector M12
- Absolute angular position is immediately available after switch on
- Non mechanical abrasion, low annual maintenance
- Vibration and shock-resistant
- Versions non programmable and programmable
- Analogue or digital output signals in CANopen and SSI with M12-plug connector
- Available in type of protection "Intrinsic safety" EEx ia IIC T6

Inclination transducers

The inclination transmitter from Camille Bauer converts the tilt angle into a direct current signal, proportional to the angle. The output signal is either available as an analog signal in form of a current change or digitally with a CANopen or SSI bus interface.

Magneto-resistive angular position transmitters are extremely robust measuring systems without a shaft stop, fully hermetically encapsulated and capable of measuring contactless the angular position of a permanent magnet, which is attached to the pendulum system.

Tilt angle values of a platform e.g. on cranes, heavy-duty vehicles, excavators and drilling machines, ships and offshore facilities stand for important measuring data as a part of the safety and control system of that type of machinery. Angular measurement, for instance for equipment levelling is performed in such cases.

For acquisition the angular position of a crane jib, lateral inclination of a vehicle, orientation of a lifting platform, weir trap or comparable facilities, alignment of solar panels or concave mirrors the KINAX N702 can also be used.

Main features

- Simple connection with plug connector M12
- Absolute angular position is immediately available after switch on
- Versions non programmable and programmable
- Analogue or digital output signals in CANopen and SSI with M12-plug connector





Temperature

Temperature is the most measured variable in industry. However, the requirements of temperature measuring points vary from one application to the other. Camille Bauer offers extensive temperature transducers in the most varied designs for the analysis, conversion and transmission of temperature sensor signals.

Head transmitters

Head transmitters are directly installed in the connecting head of the temperature sensor. The sensor signal is converted into a 4...20 mA signal, HART signal or Profibus PA signal directly on site. The head transmitters may be freely programmed and parameterised.

Transmitter for top-hat rail assembly

Intelligent terminals in 2-wire technology are suited to the installation in subdistributor systems close to the process or control cabinets. Their very small dimensions permit a space-saving installation. Temperature transmitters are directly assembled in the control cabinet and mainly use 4-wire technology. Measured variables and measuring ranges can be fully programmed which facilitates universal usage and cost-saving stocks. All of our devices are galvanically isolated, on principle, and also available in Ex-variants.

Signal conversion

As a link between the actual physical process and control engineering, we provide an extensive program for safe isolation, conversion and amplifying of signals, also for Ex-zones. Safety has the first priority also at this point.

Power Supply Units

Our power supply units provide 2-wire transducers with DC power and transmit the measuring signal 1:1 galvanically separated to the measuring output.

Isolation amplifiers

Active isolation amplifiers have the task of galvanically separating input signals from output signals, amplifying them and/or converting them to another level or type of signal (current or voltage). Different Ex-variants are also available.

Passive isolators

Passive DC signal isolators serve the galvanic isolation of a direct current signal which is transferred to a direct current or direct voltage signal depending on the device variant. They prevent the diversion of interference voltages and interference currents and solve earthing problems.

Process Management

Videographic recorders

The videographic recorders of the LINAX A300 family are paperless recorders of the latest generation. Their modular concept facilitates the flexible adaptation to the most varied needs. Depending on the type and design of the device users have up to 36 universal input channels at their disposal. Digital inputs and outputs, relay outputs, Ethernet interface, RS485 (Modbus) interface as well as transducer power supply are additional properties of the LINAX videographic recorders.

Temperature control systems

The goal of any control is to correct the change of the setpoint and the influence of interfering variables without overshooting and swinging. However, this is only possible if the controller behaves dynamically and is adjusted to the time behaviour of the controlling system. Our controllers and controller systems are the professional tool for optimum and high-quality control.

A specially developed PDPI control action and optimising procedure corrects changes without overshooting and swinging. The integrated data loggers and histories register all relevant control process data in real time thus facilitating a detailed analysis of interferences. User-friendly software tools for commissioning (configuration, parameterising), remote diagnosis and remote maintenance support and simplify all relevant tasks. Our controller program comprises compact controllers, control modules for Simatic platforms, OEM control modules, software controllers (control algorithm) and modular temperature control systems.

Index

19" assembly rack 28
2-wire technology 4

A

A200, A200-HH 28
A2000, A2000 Mobil Set 33
A210, A220, A210-HH 31
A230, A230s, A230-HH, A230E-HH 32
Analogue input module for LON 55
Angular position 70
APLUS 34

B

BT901 28
Bus termination for LON 55

C

CAM 25-27

D

Data collector module for LON 55
Data logger 25-27, 30, 32-35
Display units 28, 30-35
Display units, mobile use 28, 31-33
Display units, multifunctional 30
DME4 21
DME400 (LON) 24
DME401 / 440 (Modbus) 23
DME406 (Profibus DP) 24
DME424 / 442 22

E

ECS 46
ECS-LAN router 55
ECSopt 63
ECSwin 62
EDS-CAM 27
Electromagnetic compatibility 67
EMC 64
EMMOD201 (Modbus) 37
EMMOD202 37
EMMOD203 (Ethernet) 38
EMMOD204 (Profibus) 39
EMMOD205 (LON) 39
EMMOD206 (M-Bus) 40
EMV 67
Energy management 41
– Energy Control System (ECS) 46
– Software for energy management 62-65
– Summators 47-54
Energy meters 42-45
Environmental inspections 69
Ethernet 26, 32, 33, 35, 38
Extension modules 36-40

F

F534 13
F535 14

G

G536 15
G537 16

H

Harmonics analyses 25, 26, 32-34

I

I538 5
I542 5
I552 6
IEC 61 850 26
Inclination 70
Isolation amplifiers
– High voltage DC DC 10

L

Live-zero 4
Load optimising 56
LON 24, 33, 39, 49-55

M

M-Bus 40, 43, 52-53
M561, M562, M563 20
M56x 20
Mavolog 10S 57
Mavosys 10 58
Measuring unit CAM 25-27
Meters 42-45, 30
Mixed current 12
Mobile systems 28, 31-33
Modbus 23, 26, 33, 37

P

P200 12
P530 11
P600 12
Power meters 11, 12, 20-27
Power meters, displaying 30-35
Power quality 57, 58
PRKAB560 66
Process management 71
Profibus DP 24, 33, 39
Profibus Mini-CD 61
Programming cable 66

Q

Q531 11

R

Rogowski 27

S

Sampling systems 18
SMARTCONTROL ECS 52
Software 60-65
– CB-Analyzer 61
– CB-Manager 61

– Configuration software 60-62
– ECSopt 63
– ECSwin 62
– EMC 64
– Encore Series 65
– Makros for MS Excel 63
– METRAwin10 / Mavolog 57
– PC.doc-Access / Mavolog 57
– Z302B, Z302C, Z302D 62
Summators 46-54
– Additional components 55
System analyses 25, 34, 32

T

Time reference 25, 33, 34, 38
Transducers
– Current 4
– DC-high voltage 10
– Frequency 13
– Frequency difference 14
– Mixed current power 12
– Multifunctional 18
– Phase angle 15
– Phase angle difference 16
– Power AC 11-12, 20-27
– Power DC 12
– Power factor 15
– Unifunctional 3
– Voltage 7
– Voltage difference 10
TV829 10

U

U1281, U1289, U1381, U1387 43
U1389 43
U1500 56
U1600 48
U1600 Excel-Makro 63
U1601 49
U1602 50
U1603 51
U1660, U1661, U1664 55
U200 53
U389A, U389B 45
U539 8
U543 8
U553 9
U554 9
U700 10
Universal measuring unit 25-27

Z

Z301A, Z301B 55

Camille Bauer Our Sales Partners

Germany

GMC-I Messtechnik GmbH
Südwestpark 15
D-90449 Nürnberg

Phone +49 911 8602 - 111
Fax +49 911 8602 - 777

info@gossenmetrawatt.com
www.gossenmetrawatt.com

France

GMC-Instruments France SAS
3 rue René Cassin
F-91349 MASSY Cedex

Phone +33-1-6920 8949
Fax +33-1-6920 5492

info@gmc-instruments.fr
www.gmc-instruments.fr

Italy

GMC-Instruments Italia S.r.l.
Via Romagna, 4
I-20046 Biassono MB

Phone +39 039 248051
Fax +39 039 2480588

info@gmc-i.it
www.gmc-instruments.it

Netherlands

GMC-Instruments Nederland B.V.
Postbus 323, NL-3440 AH Woerden
Daggeldersweg 18, NL-3449 JD Woerden

Phone +31 348 421155
Fax +31 348 422528

info@gmc-instruments.nl
www.gmc-instruments.nl

Switzerland

GMC-Instruments Schweiz AG
Glattalstrasse 63
CH-8052 Zürich

Phone +41-44-308 80 80
Fax +41-44-308 80 88

info@gmc-instruments.ch
www.gmc-instruments.ch

Spain

Electromediciones Kainos, S.A.U.
Energía 56, Nave 5
E-08940 Cornellà -Barcelona

Phone +34 934 742 333
Fax +34 934 743 447

kainos@kainos.es
www.kainos.com.es

Czech Republic

GMC-měřicí technika s.r.o.
Fügnerova 1a
CZ-678 01 Blansko

Phone +420 516 482 611-617
Fax +420 516 410 907

gmc@gmc.cz
www.gmc.cz

USA

Dranetz
1000 New Durham Road
Edison, New Jersey 08818-4019, USA

Phone +1 732 287 3680
Fax +1 732 248 1834

info@dranetz.com
www.dranetz.com

Electrotek Concepts Inc.
9040 Executive Park Drive, Suite 222
Knoxville, TN 37923-4671, USA

Phone +1 865 470 9222
+1 865 531 9230
Fax +1 865 470 9223
+1 865 531 9231

info@electrotek.com
www.electrotek.com

Daytronic Corporation
2566 Kohnle Drive
Miamisburg, Ohio 45342, USA

Phone +1 937 866 3300
Fax +1 937 866 3327

sales@daytronic.com
www.daytronic.com

China

GMC-Instruments (Tianjin) Co., Ltd
info@gmci-china.cn
www.gmci-china.cn

Beijing

Rm.710, Jin Ji Ye BLD. No.2,
Sheng Gu Zhong Rd.
P.C.: 100022, Chao Yang District
Phone +86 10 84798255
Fax +86 10 84799133

Tianjin

BLD. M8-3-101, Green Industry Base,
No.6, Hai Tai Fa Zhan 6th Rd.
P.C.: 300384, Nan Kai District
Phone +86 22 83726250/51/52
Fax +86 22 83726253

Shanghai

Rm. 506 Enterprise Square BLD. No.228,
Mei Yuan Rd.
P.C.: 200070, Zha Bei District
Phone +86 21 63801098
Fax +86 21 63801098



CAMILLE BAUER

Rely on us.

Subject to change without notice
SM-1021-000-02-EN-09.10



Camille Bauer Ltd
Aargauerstrasse 7
CH-5610 Wohlen / Switzerland

Phone: +41 56 618 21 11
Fax: +41 56 618 35 35

info@camillebauer.com
www.camillebauer.com