



Fire stop barriers
FIRE - STOP



A FIRE STOP-BAG fire stop barrier in intumescent bags

REI180

Intumescent incombustible bags which stop the passage of fire through openings in walls. They are available in different sizes and they have to be placed to seal the openings, both in walls and floor slabs. At a temperature of 200 ° the material starts to compact sealing the gaps thus avoiding the passage of the flames.

Characteristics

Packed with fireproof material, filled with mineral fibres and expandable compounds.

Approval

- Up to class REI 180; for plasterboard walls, refer to REI 120.
- Non toxic and asbestos free.
- In compliance with circular no. 91/61.

Installation

Finish and opening then lay, the bags as bricks, staggered and overlapped.

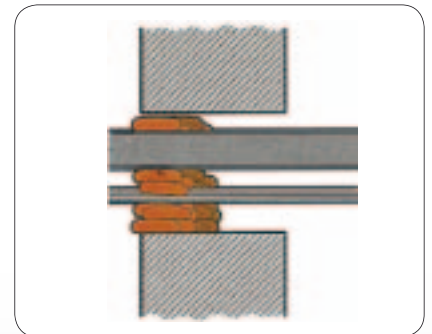

Product code	Bag dimensions (mm)
FSB-11	250 x 100 x 25
FSB-12	250 x 200 x 35
FSB-13	250 x 300 x 35

For the application on plasterboard walls please contact Raytech

B FIRE-STOP PANEL fire stop barriers in panels

REI180

Incombustible panels treated on the surface with intumescent paint to stop the passage of fire through openings in walls. Their application allows the sealing of openings in walls in a safe and cheap way.

Characteristics

Made of mineral wool and treated on the surface with intumescent, bacteria and mould resistant paint.

Approval

- Up to class REI 180; for plasterboard walls, refer to REI 120.
- Non toxic, asbestos and solvent free
- In compliance with circular no. 91/61

Installation

Finish and clean the opening edges then cut the panels with a cutters and position them in the opening. The edges and the jointing lines, as well as the interstices among the cables, are sealed and covered with FIRE STOP SEAL FSS sealant.

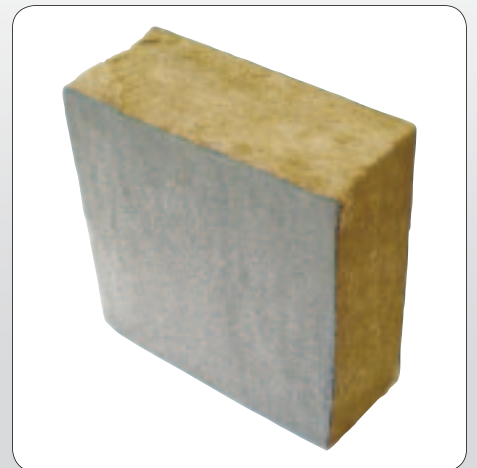

Product code	Panel colour	Panel dimensions
FSP-11	Grey	600 x 500 x 54

For the application on plasterboard walls please contact Raytech

C FIRE STOP COLLAR fire stop barrier for the pass through of plastic pipes

REI180

Prefabricated metal collars for the closing of pass through of plastic tubes. Available in a wide range of dimensions they are applied to surround the plastic tube and fixed to the wall.

Characteristics

Made of stainless steel they are supplied with internal gaskets made of intumescent material, which expands in case of fire to completely close the plastic tube.

Approval

- Up to class REI 180; for plasterboard walls, refer to REI 120.
- Non toxic, asbestos and solvent free
- In compliance with circular no. 91/61.

Installation

They do not need particular care; the opened collar is positioned around the cable supporting tube, closed and fixed to the wall by means of plugs.

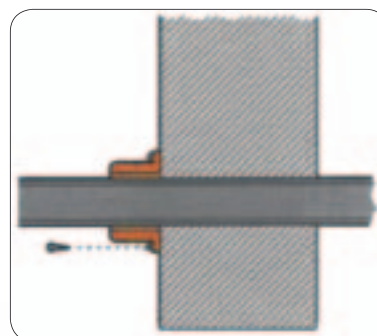

Product code	Diameter (mm)
FSC 11	From 40 to 110
FSC 12	From 140 to 160
FSC 13	200
FSC 14	250

For other dimensions and the installation in plasterboard walls please contact Raytech

D FIRE STOP TAPE fire stop barrier in intumescent tape for the closing of the pass-through of plastic tubes

REI180

Preformed intumescent tape with high expansion properties for the closing of pass through of with plastic tubes (PVC, PE,PP, Geberit, etc) on walls. It is surrounds the tube in the pass through; with the heat caused by the fire it expands to close all interstices to prevent the fire propagation.

Characteristics

The proposed solution is 1m long, and it can be cut at the required length, saving the remaining parts for a future application.

Approval

- Up to class REI 180.
- Non toxic, asbestos and solvent free
- In compliance with circular no. 91/61.

Installation

They do not need particular care; the tape is applied around the plastic tube, according to the diameter, between the tube and the hole in the wall. It can be useful to seal the edges of the hole with FIRE STOP SEAL FSS sealant.

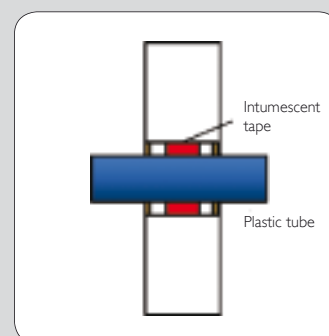

Product code	Range of diameters on the tube (mm)	Tape length
FST 250/40/1000	40 to 250	1 m

E FIRE STOP SEAL fire stop barrier in intumescent sealing mastic

REI180

Intumescent mastic to seal and close small passages in walls, also in addition to other types of barriers. It is applied to seal the passage or to install barriers on cable ducts.

Characteristics

Made of polymers, fireproof fibres and intumescent non-hygroscopic and thixotropic materials in water solution. The /S type, more fluid, can be sprayed or applied with a spatula.

Approval

- Up to class REI 180; for plasterboard walls, refer to REI 120.
- Non toxic and asbestos free.
- In compliance with circular no. 91/61.

Installation

After the edges of the openings have been finished and cleaned, the sealant is applied with a spatula for products in drums, with a gun for silicone in case of products in cartridge, or applied with a spatula or sprayed in case of the /S type product.

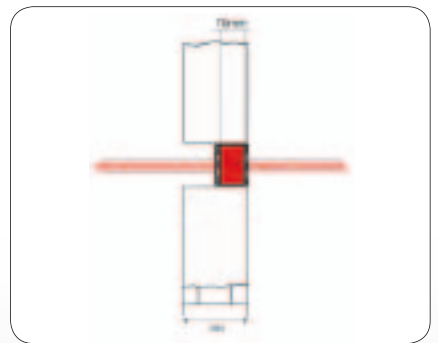

Product code	Package
FSS 310	0,3 kg cartridge
FSS 5	Spatula type, 5 kg drum
FSS 15	Spatula type, 15 kg drum
FSS/S 5	Spray or spatula type, 5 kg drum
FSS/S 15	Spray or spatula type, 15 kg drum

For other dimensions or the application on plasterboard walls please contact Raytech

F FIRE STOP FOAM fire stop barriers in expanding foam

REI120

Sealing and expanding, one-component foam for the sealing of small openings in walls with a thickness of at least 100 mm. The expanded volume of every can is about 45 lt.

Characteristics

Made of polyurethane fireproof foam charged with graphite, it hardens when in contact with air. Also suitable for the protection of plasterboard walls.

Approval

- Up to class REI 120.
- Non toxic, asbestos free; they do not emit toxic gases or thick fumes.
- In compliance with circular no. 91/61.

Installation

After the edges of the openings have been cleaned, shake the can for at least 30 seconds, then turn upside down and spray the product.

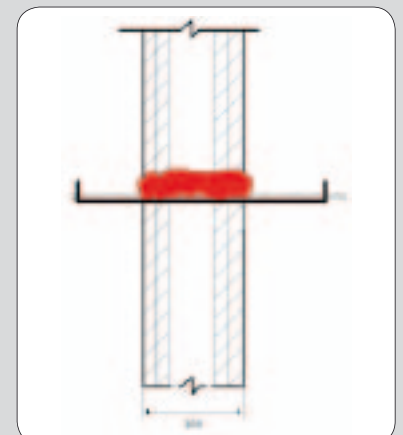

Product code	Package
FSF 700	700 ml can

G FSM fire stop barriers in incombustible plaster

REI180

Protective coating to seal and prevent fire propagation of openings in walls; it can be applied manually or sprayed. It can be easily mixed in big quantities with suitable mixer (e.g. concrete mixer).

Characteristics

Made of mineral fibres, it can be mixed with water also by means of concrete mixers. Once applied the product is insensitive to moisture.

Water quantity: about 0,8 lt/kg (volume 1 kg = about 2 dm³)

Approval

- Up to class REI 180.
- Non toxic, asbestos and solvent free; it does not emit toxic gases and dense fumes.
- In compliance with circular no. 91/61.

Installation

After the edges of the openings have been finished and cleaned, the incombustible plaster is mixed with water, than applied manually, with a spatula or a pump, and left to dry in air.

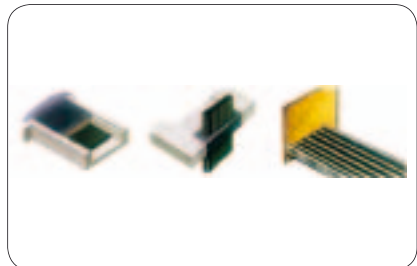

Product code

FSM 20

Package

20 kg bag

For other applications please contact Raytech

H FSCP fire stop barriers for ceiling lights covering

REI120

Incombustible barrier for the ceiling lights covering to maintain the integrity of the fire resistance at ceilings.

Characteristics

Made of non toxic mineral, fire resistant fibres; it avoids the propagation of the fire and reduces the temperature in the space between slabs and false ceiling. Flexible, light, self-supporting and easy to install and remove.

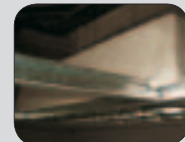
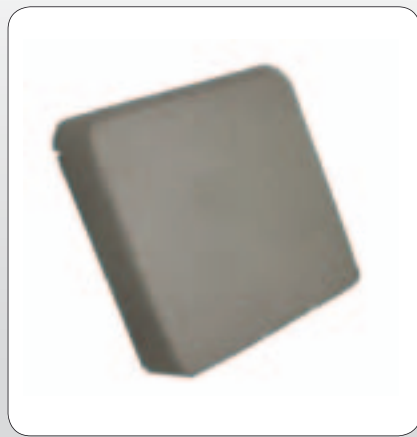
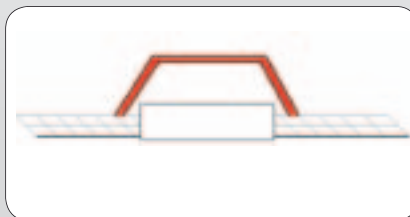

Approval

- Up to class REI 120.
- Non toxic.

Installation

No special care is required. The protection must be placed on the ceiling light grid adhering to the panel.

Product code

FSCP 600

FSCP 1200

Dimensions

720x750x150

1330x700x140

Weight

about 1,7 Kg

about 3,5 Kg



For other applications please contact Raytech

I FSCF fire stop barriers for spotlights covering

REI120

Incombustible barrier dome for the covering and protection of spotlights in false ceilings; to maintain the integrity of the fire resistance of ceilings.

Characteristics

Made of non toxic fireproof mineral fibres and expandable compounds (which expand up to 5 times the initial volume), it inhibits the propagation of fire and reduces the temperature in the interstices between false ceiling and the slab. With ventilation holes, it avoids the overheating of the lamp. Flexible, light and self-supporting, it is easy to install and remove.

Approval

- Up to class REI 120.
- Non toxic.
- It expands up to 5 times.

Installation

No special care is required. The protection must be placed on the spotlight, adhering to the panel.

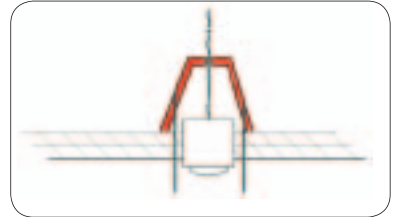

Product code	Dimensions	Type
FSCF 250	250x280	Cone-shaped type
FSCF 350	350x230	Dome-shaped type

For other dimensions please contact Raytech



L FSCI fire stop barrier for switchgear covering

REI120

Incombustible intumescent barrier for the switchgear to maintain the integrity of the fire resistance of the walls.

Characteristics

Made of fireproof fibres and intumescent materials, it reduces the temperature in the wall interstices protecting from the fire propagation.

Approval

- Up to class REI 120.
- Non toxic.

Installation

No special care is required. The protection must be placed on the box, adhering to the wall.

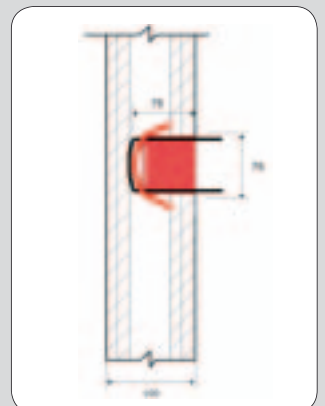

Product code	Dimensions
FSCI 150	150 x 150 mm

For other dimensions please contact Raytech

M FSCC fire stop barrier for boxes covering

REI120

System for the protection of electric and termination boxes made of a fire resistant closing; it protects the wall from heat and fire propagation.

Characteristics

The casing is made of calcium silicate, and it contains the box.

Approval

- Up to class REI 120.
- Non toxic and asbestos free; they do not emit toxic gases and dense fumes.
- In compliance with circular no. 91/61.

Installation

After the opening edges have been finished and cleaned, the protection is properly placed and fixed to the wall by means of screws and putty.

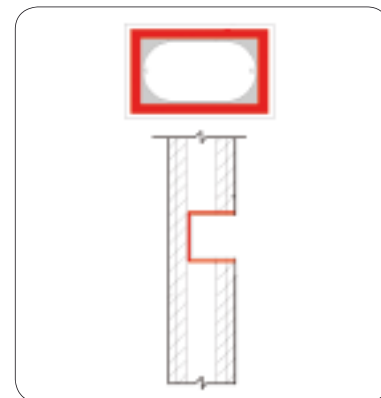
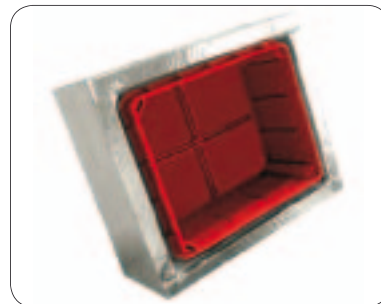

Product code	External dimension	Internal dimension
FSCC 150	150 x 120 x 75 mm	110 x 80 x 55 mm
FSCC 200	200 x 170 x 75 mm	160 x 130 x 55 mm

For other dimensions please contact Raytech

N FSTP - FIRE STOP TUBE PROTECTION fire stop intumescent sleeve

REI120

Fireproof intumescent sleeve to close the pass through of metal or plastic tubes to ensure the protection against fire propagation. Available in a wide range of diameters, they are applied to seal the opening. In case of fire the sleeve expands avoiding the passage of the flames.

Characteristics

Made of a fireproof and intumescent material, they have a standard length of 300 mm and a thickness of 25 mm. Available for internal diameters from 15 to 170 mm.

In case of plastic tubes, the expansion completely close the opening.

Approval

- Up to class REI 120.
- Non toxic and asbestos free.
- In compliance with circular no. 91/61.

Installation

After the opening edges have been finished and cleaned, the sleeve is cut to measure, opened longitudinally, inserted on the tube, then positioned in the wall.



Product code	Inner dimensions
FSTP 25	25 mm
FSTP 50	50 mm
FSTP 100	100 mm

Use sequence

